

SHETLAND - 21

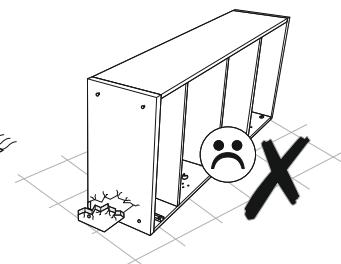

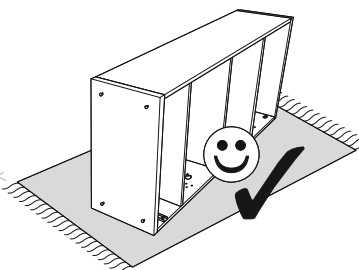
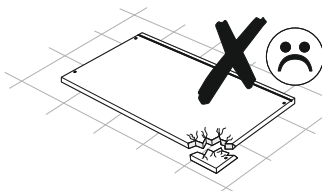
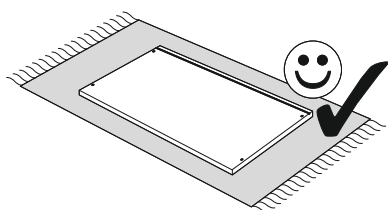
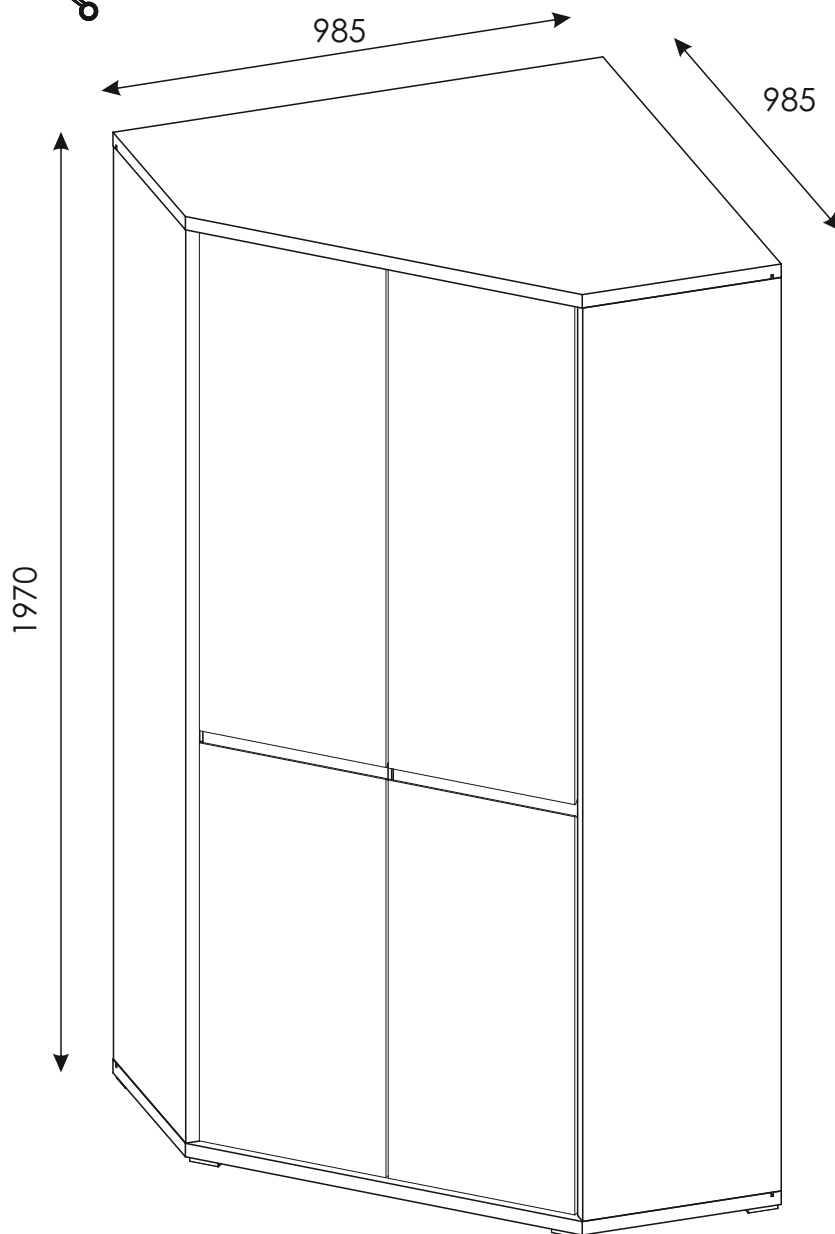
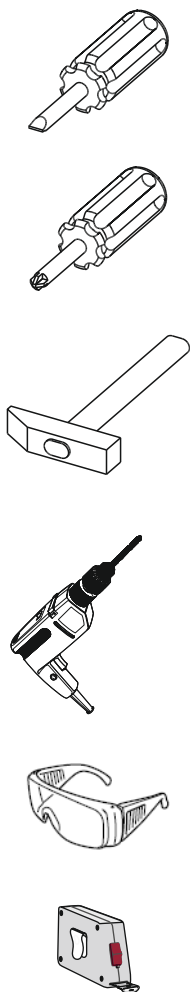

PL.
UWAGA! Mebel należy trwale zamocować do ściany, aby uniknąć ryzyka związanego z przewróceniem się mebla.

W paczce nie ma śrub mocujących, ponieważ rodzaj mocowania należy odpowiednio dobrać do rodzaju ściany. Dobierz właściwe do Twojego rodzaju ściany.

SK.
POZOR! Nábytok musí byť trvalo pripevnený k stene tak, aby sa zamedzilo riziku prevrátenia. Balík neobsahuje upevňovacie skrutky, pretože typ upevnenia je treba vybrať podľa typu steny. Vyberte typ vhodný pre Vašu stenu.

FR.
ATTENTION! Ce meuble doit être fixé en permanence au mur pour éviter les risques de chute. Les vis de fixation ne sont pas livrées car le type de fixation doit être choisi en fonction du type de mur. Sélectionnez les fixations adaptées au mur.

HU.
FIGYELEM! Rögzítse a bútorokat a falhoz, hogy elkerülje a bútor felborulásának kockázatát. A készletben nem található a rögzítőcsavarok, mivel a rögzítés típusa a fal típusától függ. Válassza ki a fal típusának megfelelő kötőelemeket.

HR.
NAPOMENA! Namještaj mora biti trajno pričvršćen za zid, kako bi se izbjegao rizik od njegova prevrtanja. U paketu nema vijaka za pričvršćivanje, jer se vrsta montaže mora prilagoditi vrsti zida. Odaberite pravu vrstu prema Vašoj vrsti zida.

EN.
WARNING! To prevent this furniture from tripping over, fix it to the wall permanently. Fixing devices are not included since different wall materials require different types of fixing devices. Please make sure you chose the correct ones for your type of wall.

D.
ACHTUNG! Um alle mit dem Umkippen des Möbels verbundenen Risiken auszuschließen, muss das Möbel fest an der Wand verankert werden. Beschläge für die Wandbefestigung sind nicht beige packt, da diese von der jeweiligen Wandbeschaffenheit abhängig sind. Bitte solche Befestigungsschläge wählen, die für die heimischen Wände geeignet sind.

CZ.
POZOR! Nábytek je nutné pevně připevnit ke zdi, abychom se vyhnuli riziku spojenému s jeho převrnutím. Součástí balení nejsou připevňovací šrouby, protože způsoby připevnění je nutné zvolit podle druhu stěny. Vyberte správný pro Váš typ stěny.

E.
¡ATENCIÓN! El mueble debe ser fijado permanentemente a la pared para evitar el riesgo relacionado con el vuelco del mueble. En el paquete no hay tornillos de fijación, ya que se debe elegir el tipo de fijación adecuado para el tipo de pared. Elija el apropiado para su tipo de pared.

CN.
注意！本家具需要固定在墙上以免倒塌。箱子里没有安装螺钉，因为安装方式需要根据墙的类型调整。请按照您的墙类型选择合适的安装方式。

RU.
ПРИМЕЧАНИЕ! Эту мебель необходимо всегда прикреплять к стене, чтобы избежать рисков, связанных с переворотом мебели. В пакете нет крепежных винтов, потому что тип крепления должен быть выбран в соответствии с типом стены. Выберите, пожалуйста, правильные винты к вашей стене.











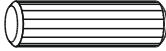
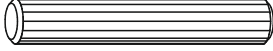
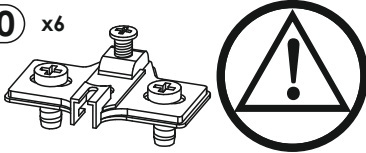
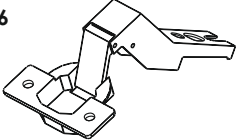
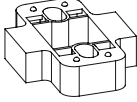

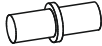



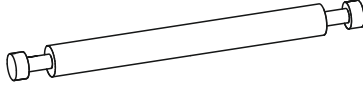

SLO.
POZOR! Pohištvo trajno pritrdite na steno, da preprečite tveganje, da se prevrne. V paketu ni pritrdilnih vijakov, saj je treba način pritrditve ustrezno izbrati glede na vrsto stene. Izberite način, ki je ustrezen za vašo steno.

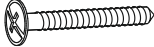
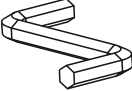
I.
ATTENZIONE! Il mobile deve essere permanentemente fissato alla parete per evitare i rischi derivanti da un ribaltamento del mobile. La confezione non include le viti di fissaggio, in quanto il tipo di fissaggio deve essere scelto in base al tipo di parete. Utilizzare viti appropriate in base al materiale della parete.

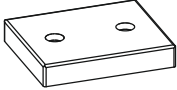

SHETLAND -21

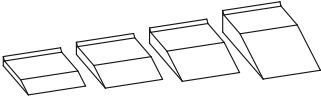
MM

<p>A1 x20 $\varnothing 8 \times 35$mm</p> 	<p>A3 x 2 $\varnothing 8 \times 60$ mm</p> 	<p>B0 x6</p> 
<p>B5 x6</p> 	<p>BD x6</p> 	<p>C1 x12 EURO 4 x 13mm</p> 
<p>C6 x12 $\varnothing 6 \times 30$mm</p> 	<p>D2 x25</p> 	<p>E0 24</p> 
<p>E1 24 $\varnothing 15 \times 12$mm</p> 	<p>F1 x20</p> 	<p>F4 x 2 $\varnothing 7 \times 82$ mm</p> 
<p>G0 x8</p> 	<p>G2 x8 $\varnothing 7 \times 60$mm</p> 	<p>I2 x2 4 x 16mm</p> 
<p>I12 x8 4 x 30mm</p> 	<p>M x1</p> 	<p>N2 x14 US 3,5 x 16mm</p> 
<p>O15 x6</p> 	<p>P4 x 2</p> 	<p>Q9 x2</p> 
<p>R4 x26</p> 	<p>Z x1</p> 	<p>Z1 x 1 L-931</p> 

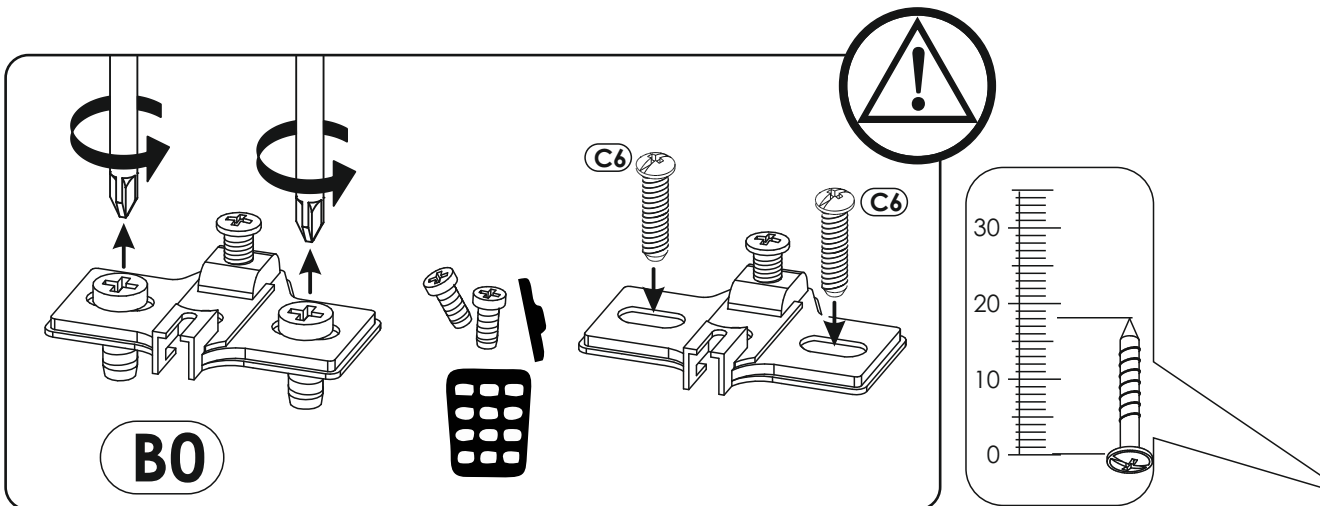
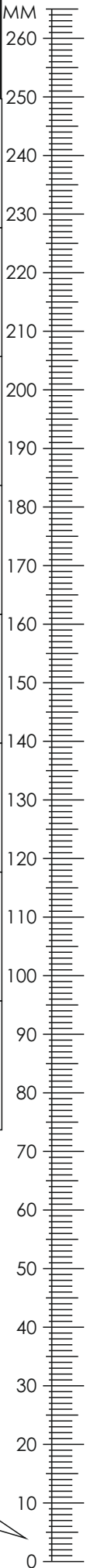

SHETLAND - 21

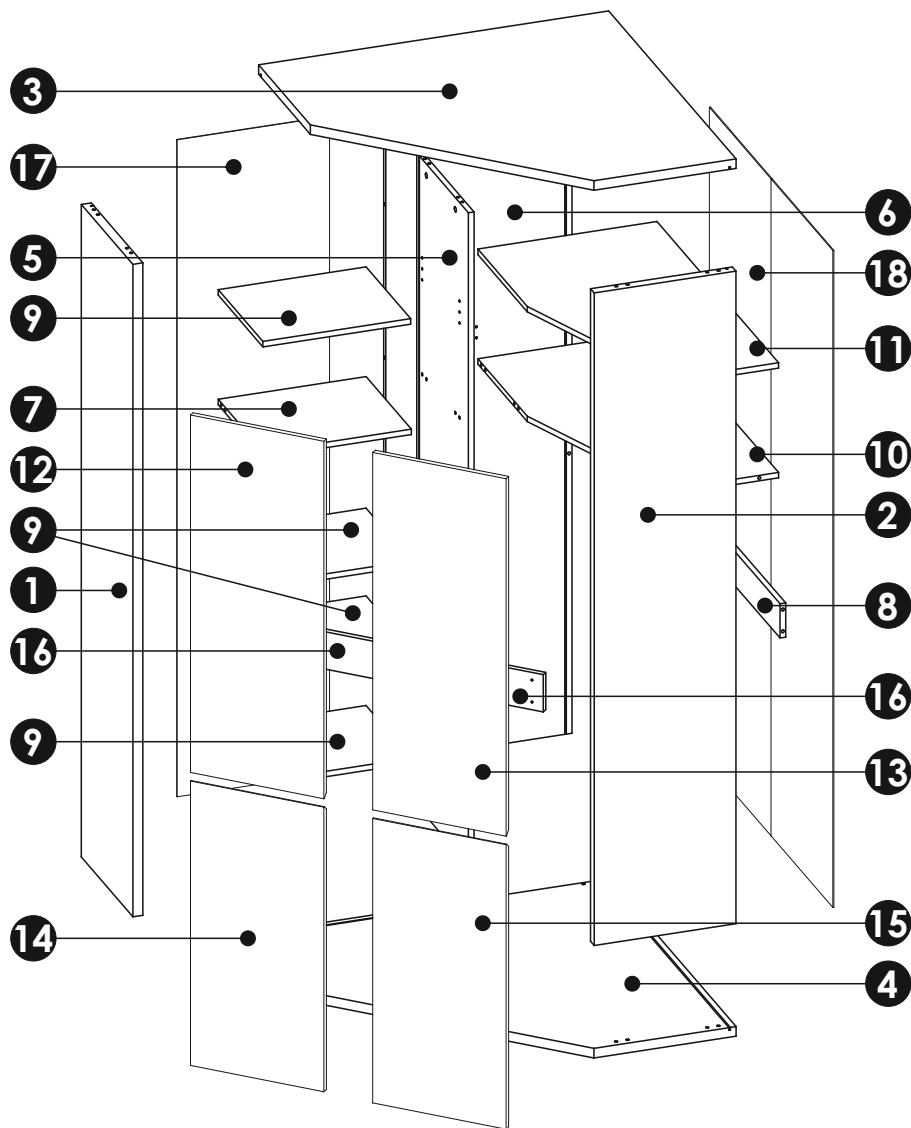
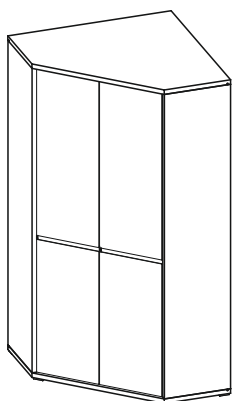

1	1904	399	28	x1	3/4
2	1904	399	28	x1	3/4
3	985	985	28	x1	4/4
4	985	985	28	x1	4/4
5	1904	399	16	x1	2/4
6	1904	524	16	x1	2/4
7	416	350	16	x1	3/4
8	940	100	16	x1	1/4
9	416	350	16	x4	2/4
10	940	504	16	x1	1/4
11	940	504	16	x1	1/4
12	389	1043	16	x1	1/4
13	389	1043	16	x1	1/4
14	389	830	16	x1	1/4
15	389	830	16	x1	1/4
16	386	109	16	x2	1/4
17	1917	429	3	x1	2/4
18	1917	952	3	x1	2/4

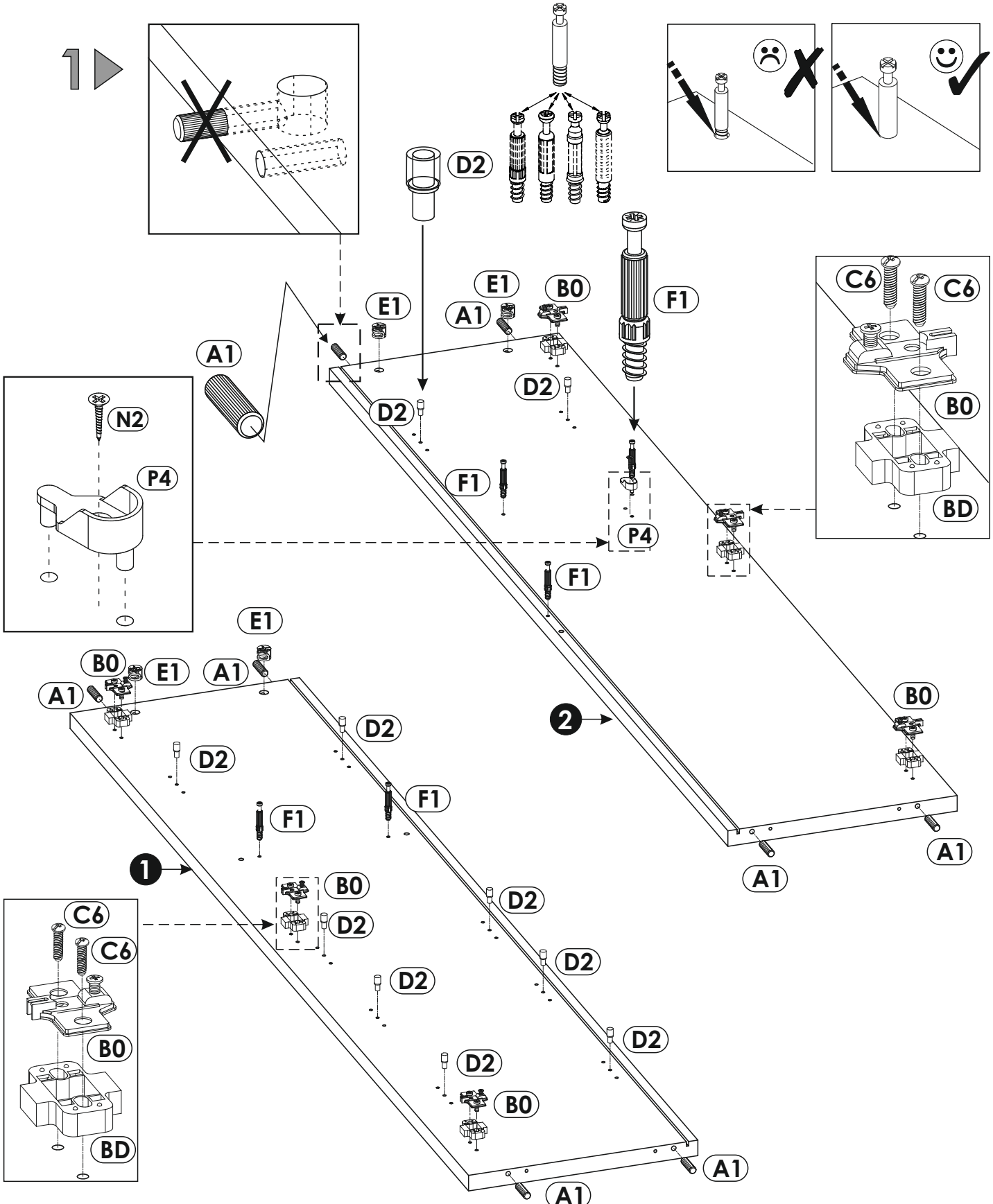
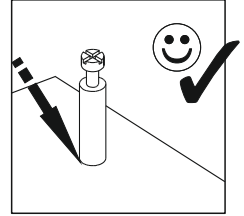
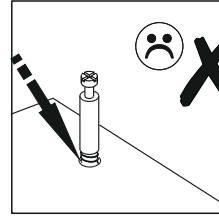
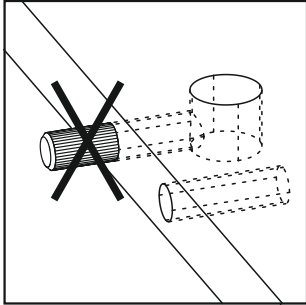

2 ▶

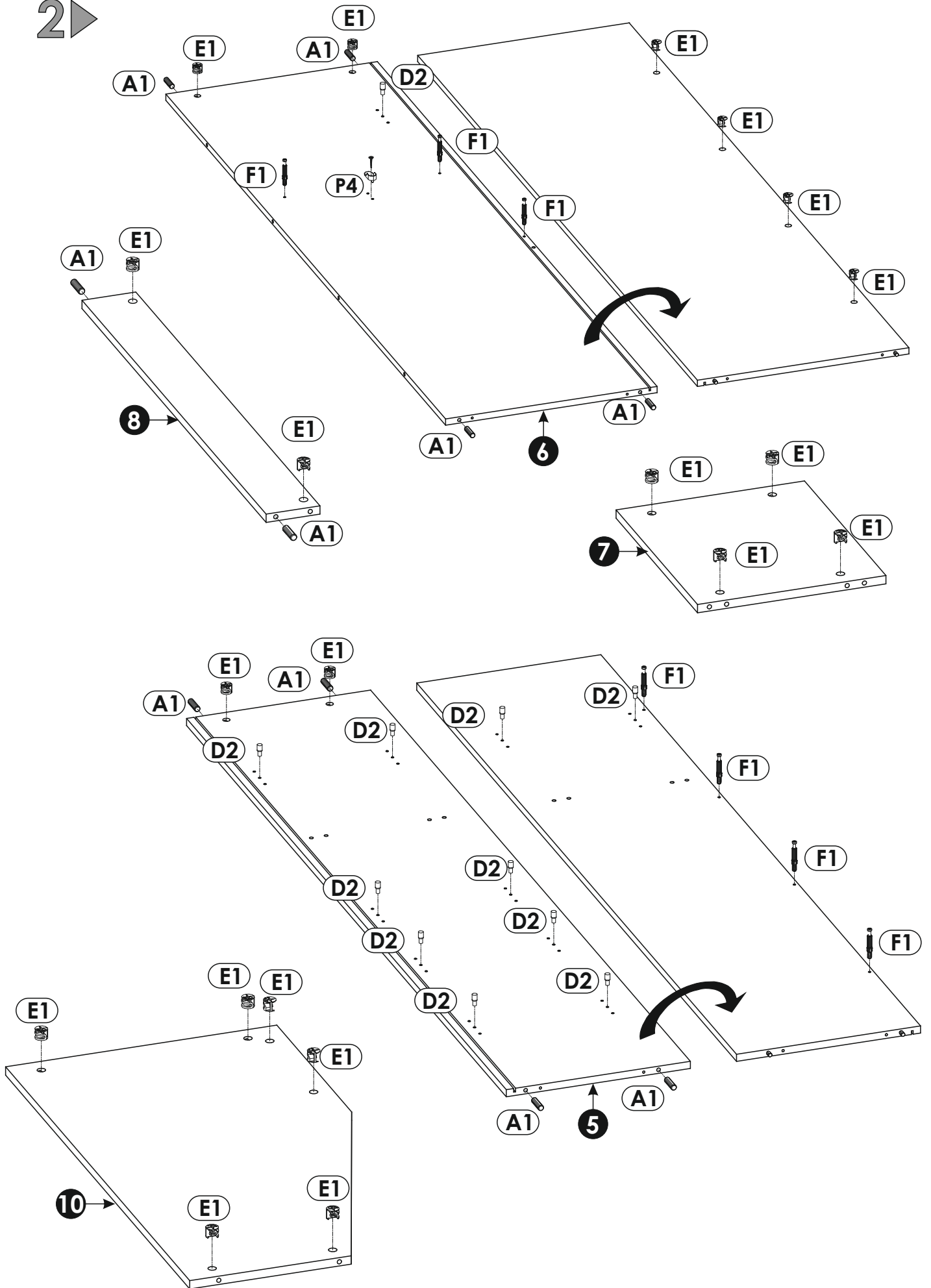

3 ▶

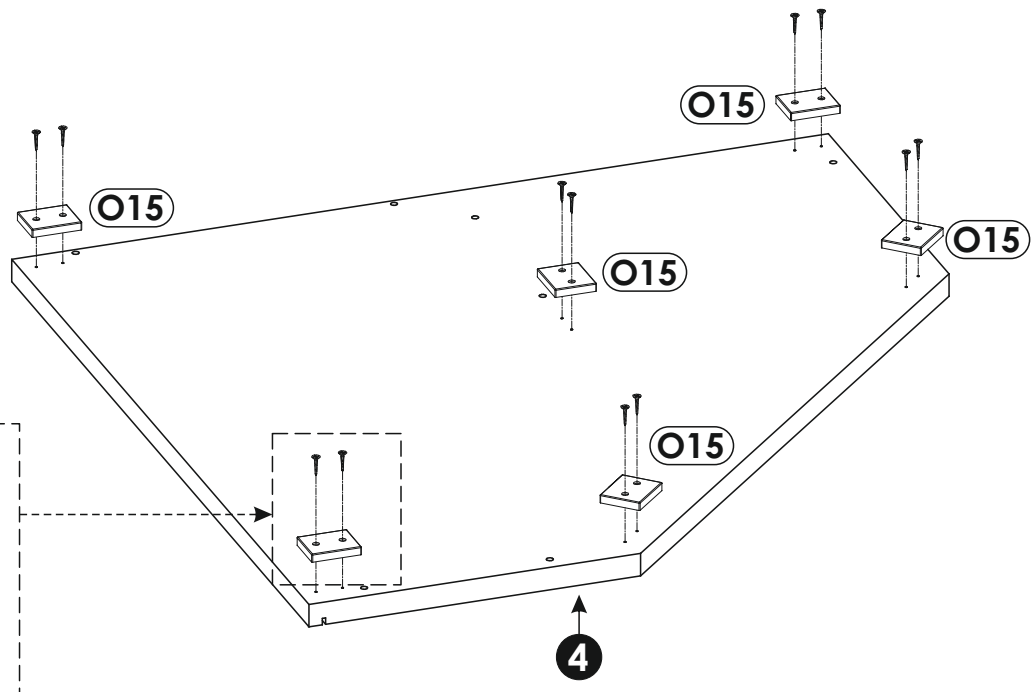
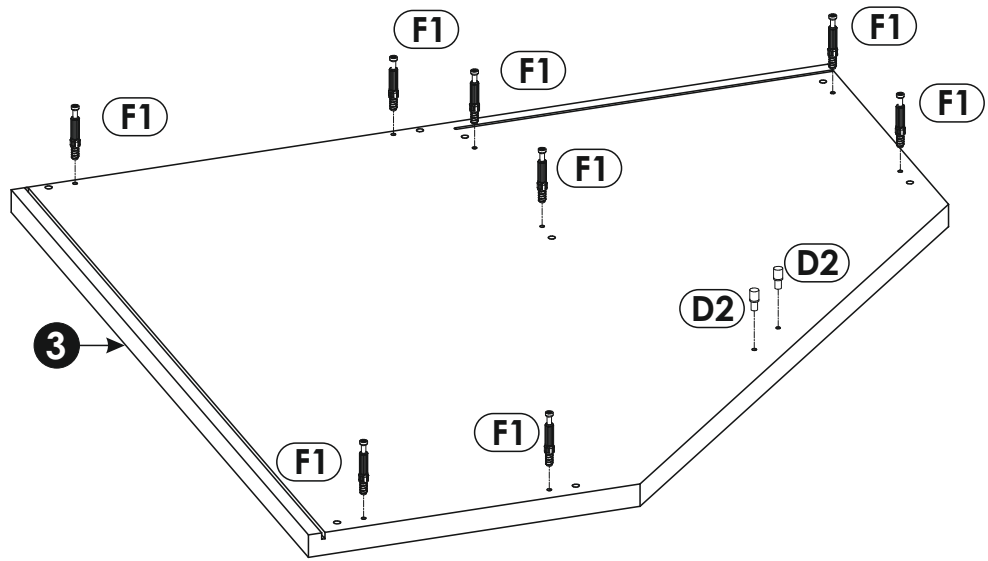

4 ▶

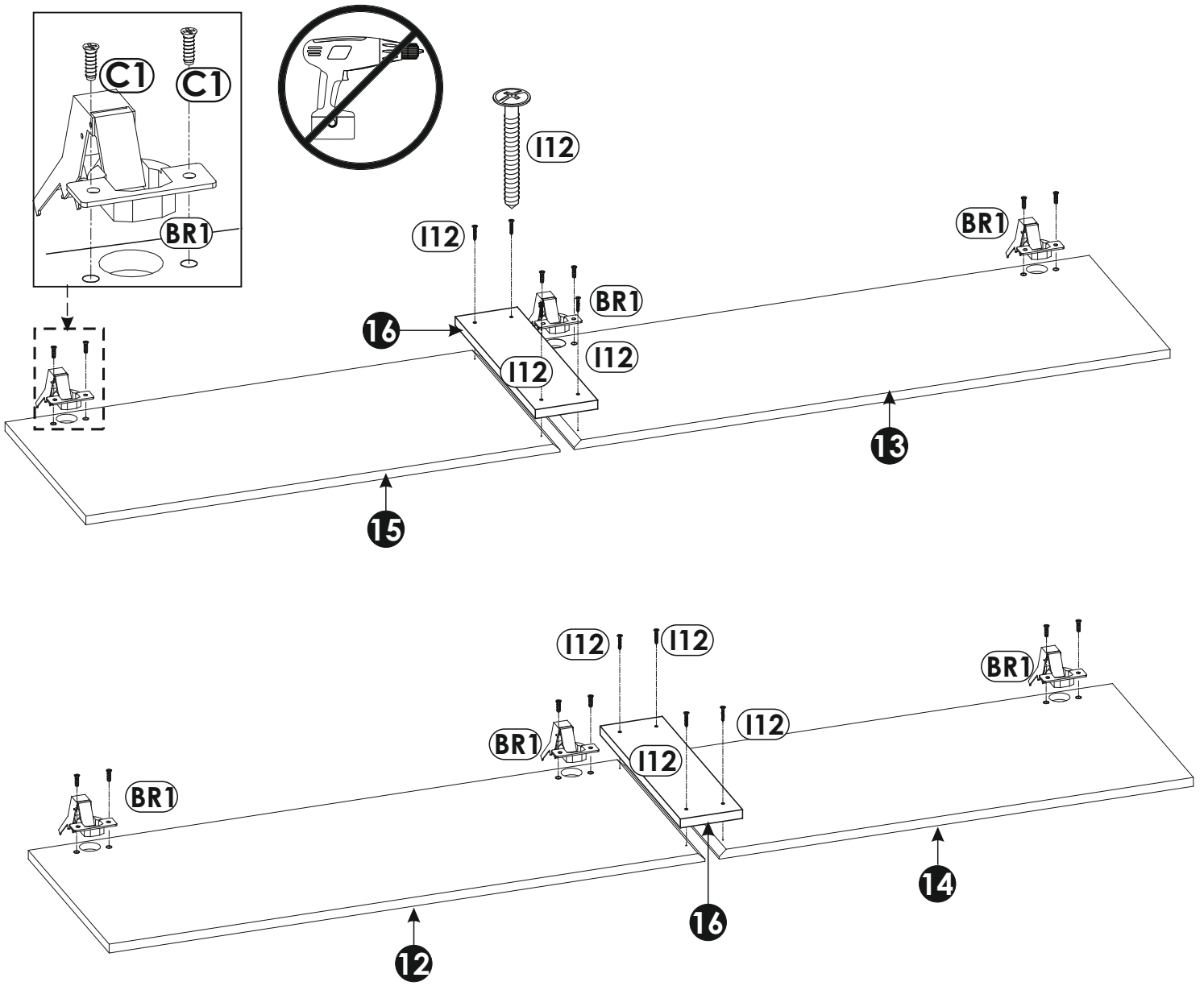

5 ▶

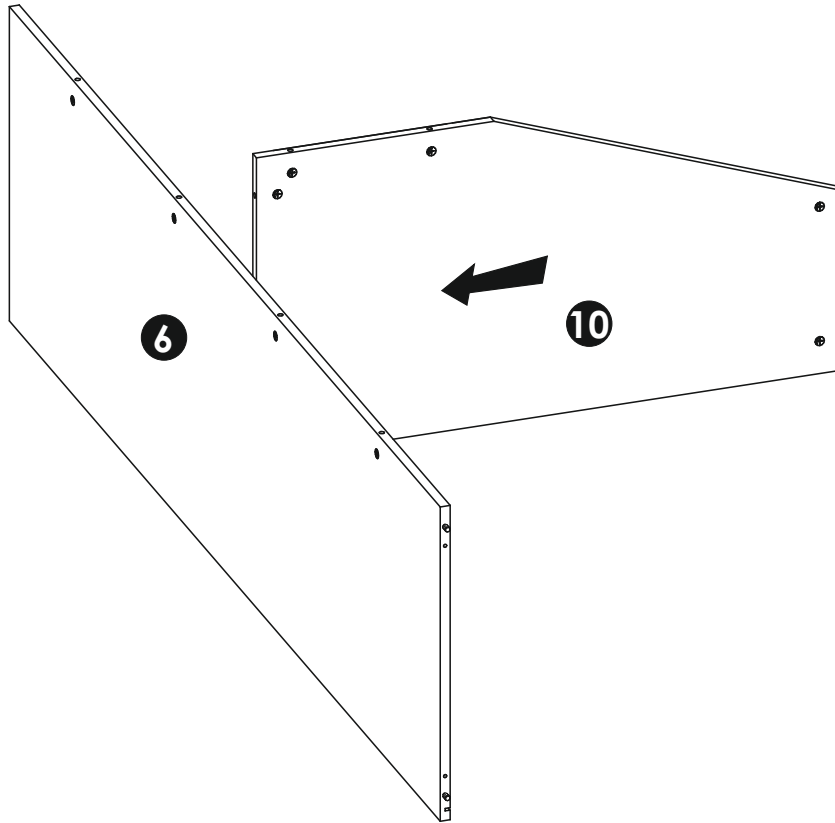

6 ▶

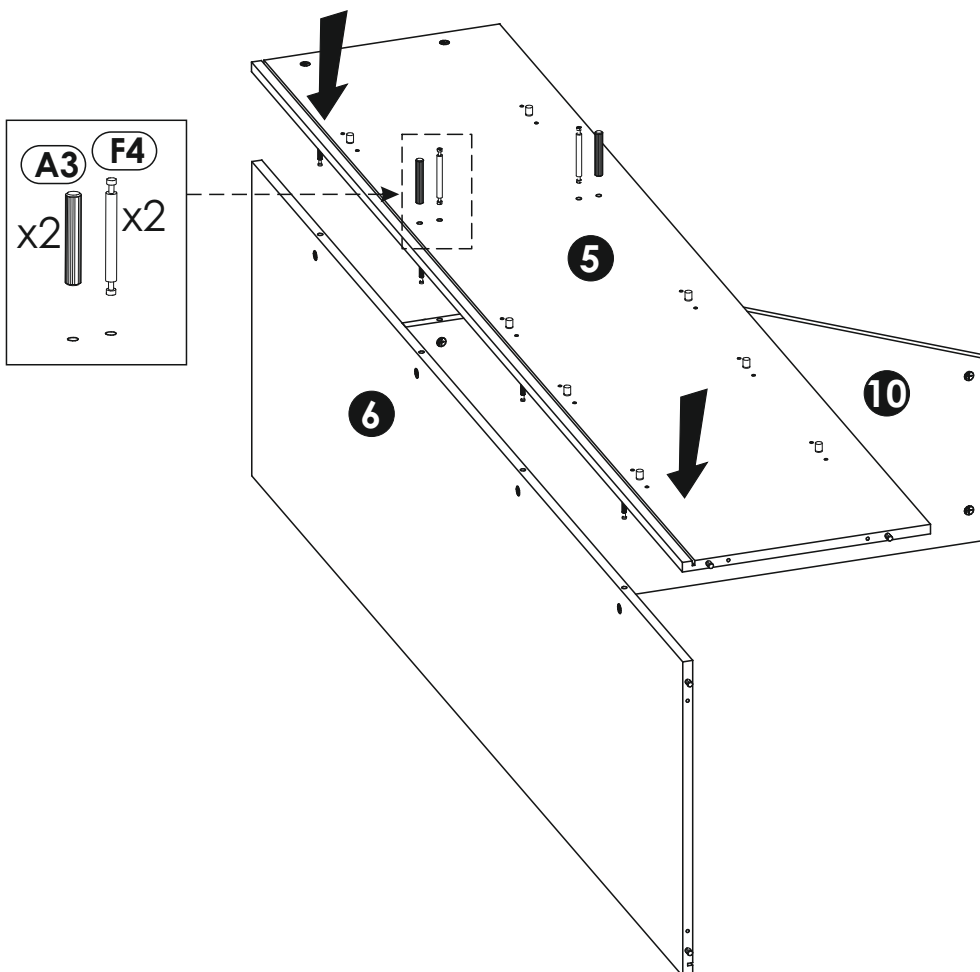

7 ▶

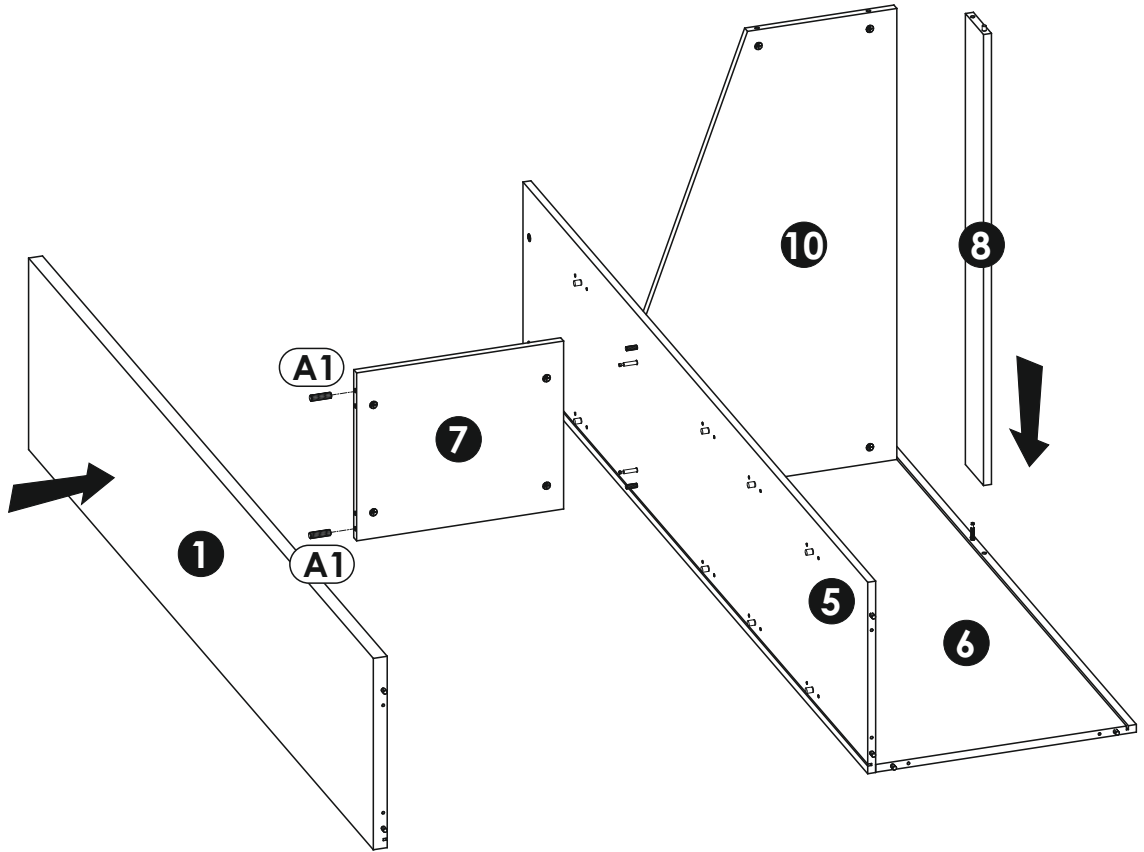

8 ▶

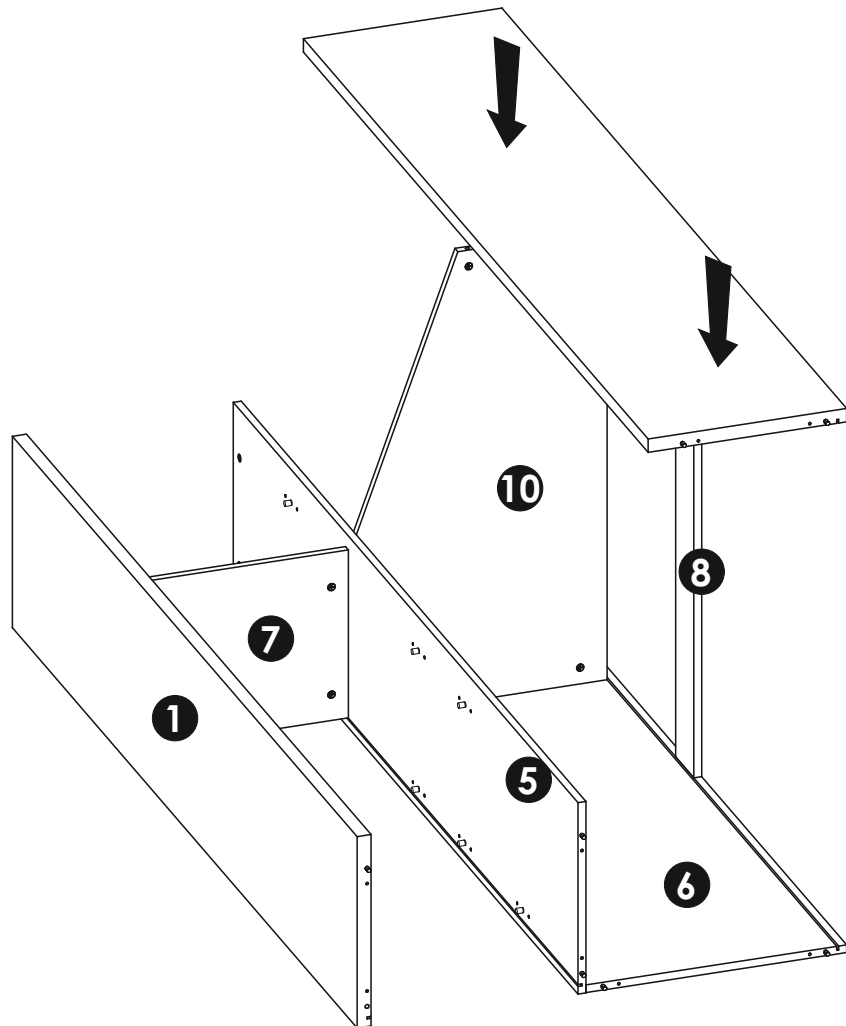

9 ▶

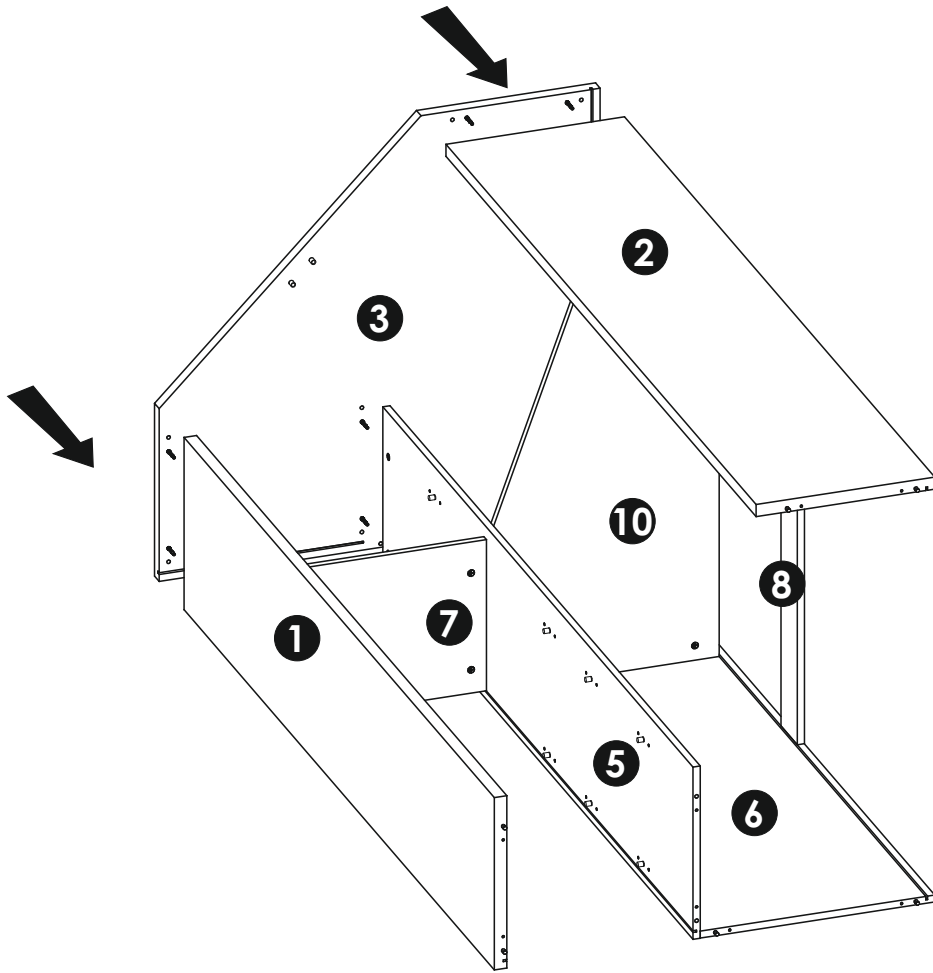

10 ▶

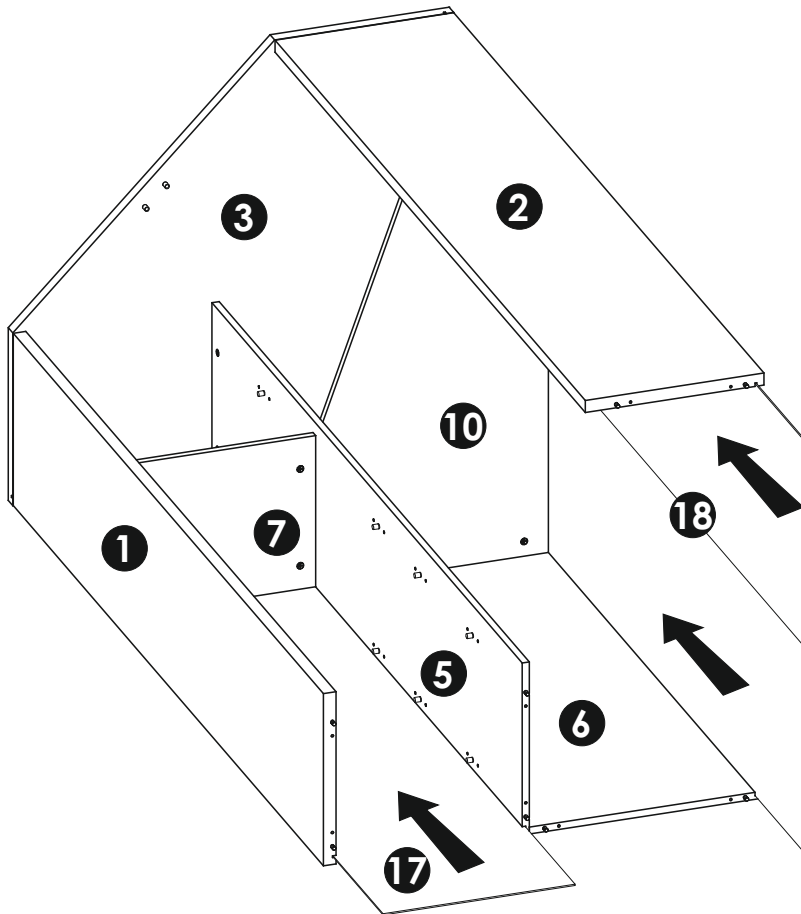

11 ▶

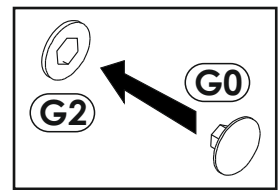
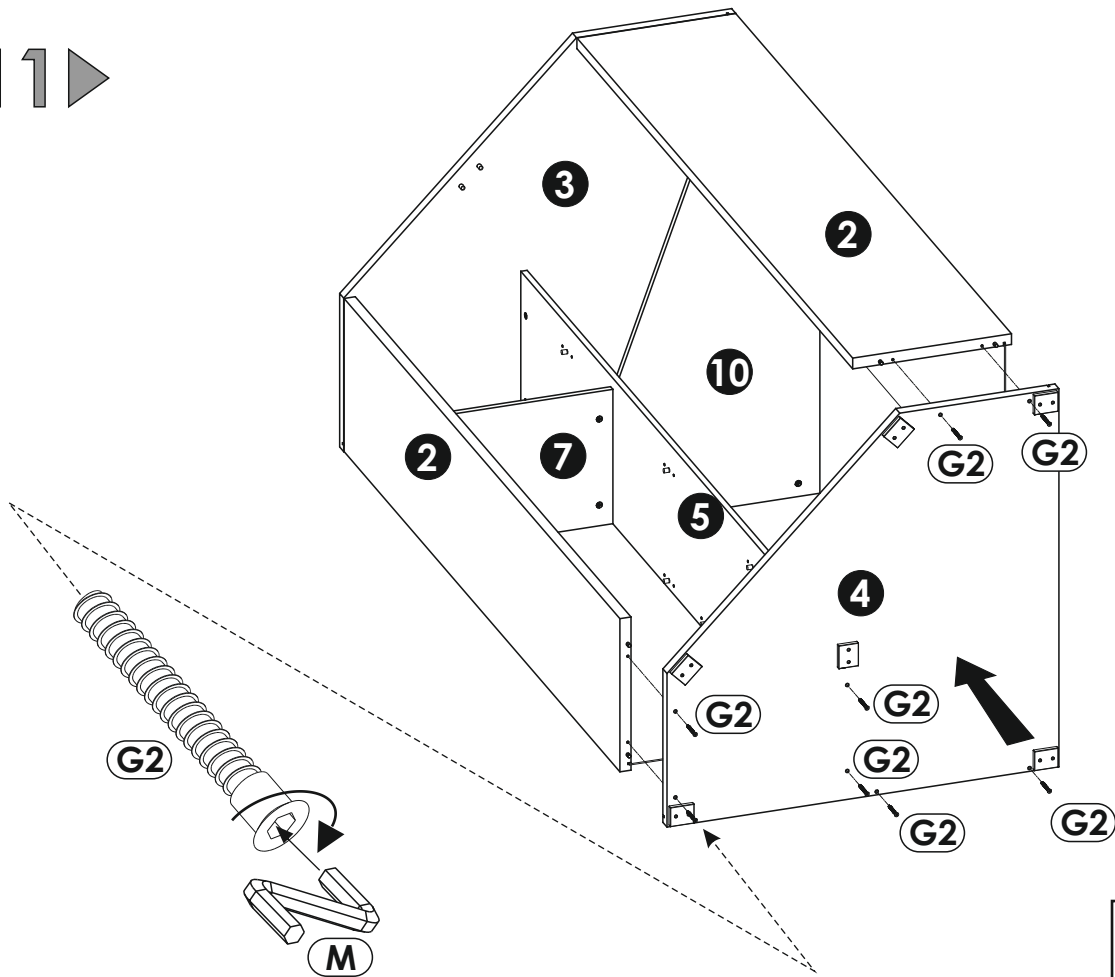

12 ▶

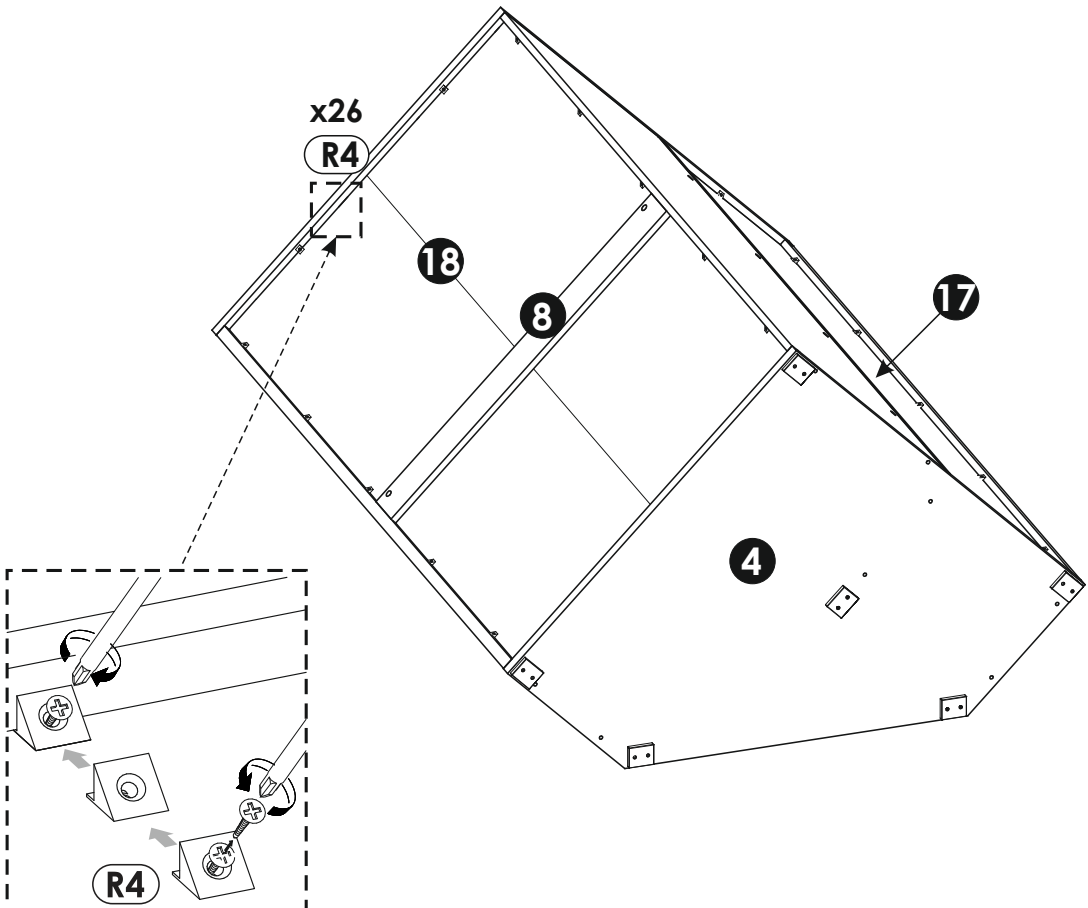
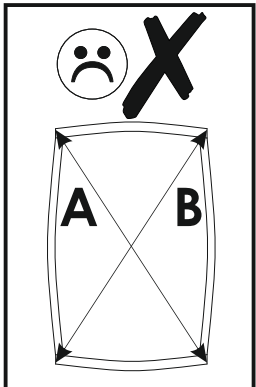
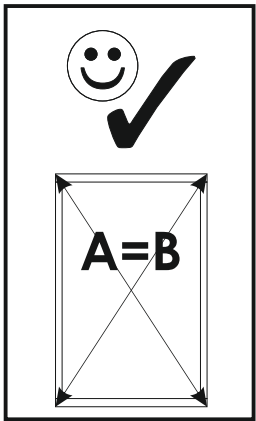

13 ▶

