

SAIF02

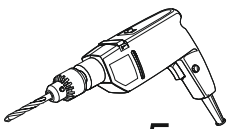

140 min

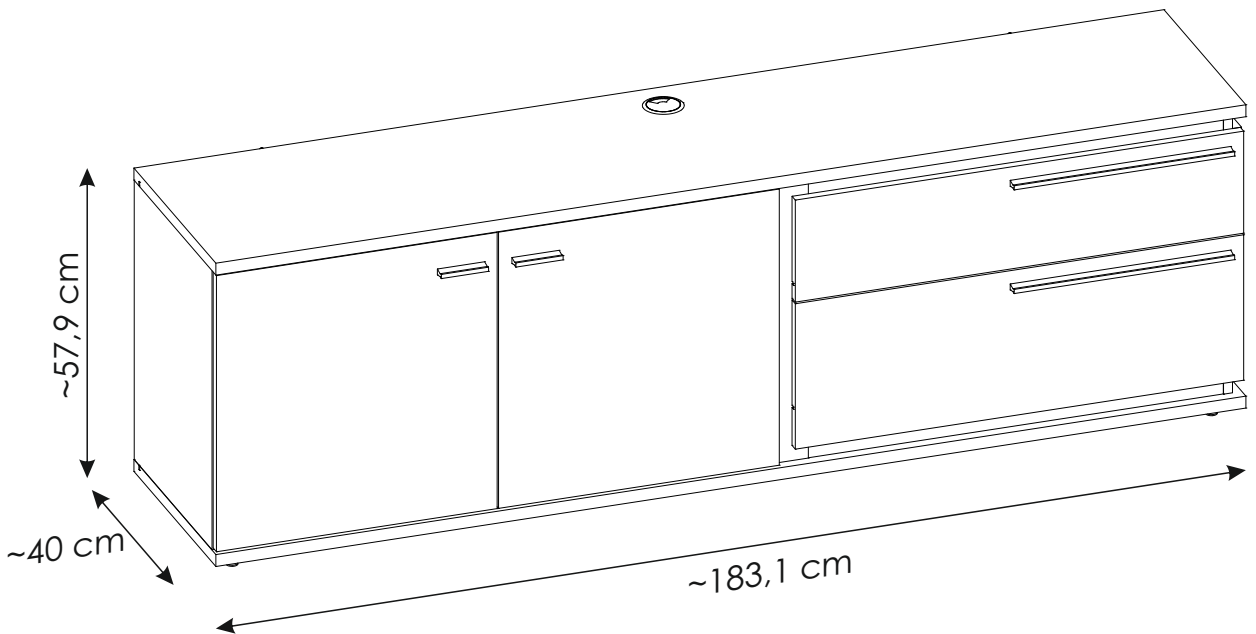
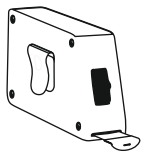
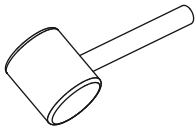
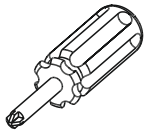
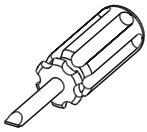
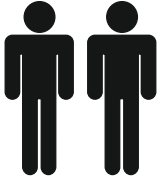

Ø5
Ø8

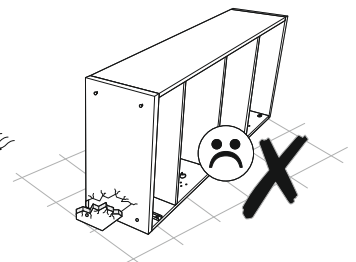
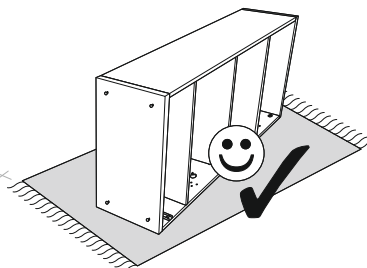
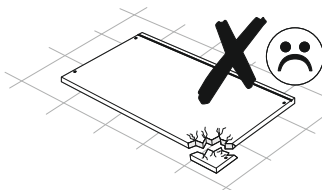
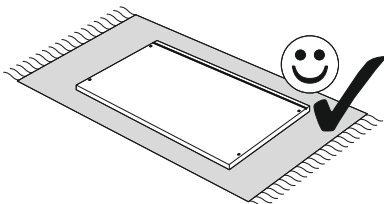

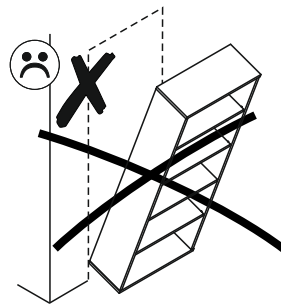
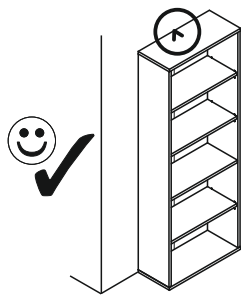

AR. ملاحظة!

يجب تثبيت الأثاث بإحكام إلى الحائط أو الجدار لتجنب خطر إنقلابه. تحتوي العلبة على مسامير التثبيت التي تناسب الجدران الخرسانية أو الطوب. إذا كان جدارك مصنوعاً من مادة مختلفة أو لم تكن متأكداً من مادة بناء أسأل المتخصص عن كيفية التثبيت.

PL.

UWAGA! Mebel należy trwale zamocować do ściany, aby uniknąć ryzyka związanego z przewróceniem się mebla. W paczce znajdują się elementy mocujące odpowiednie wyłącznie do ścian betonowych lub z pełnej cegły.

Jeśli Twoja ściana wykonana jest z innego materiału lub nie masz pewności co do budowy tej ściany, skonsultuj się w kwestii montażu ze specjalistą.

D.

ACHTUNG! Um alle mit dem Umkippen des Möbels verbundenen Risiken auszuschließen, muss das Möbel fest an der Wand verankert werden.

Die im Paket enthaltenen Beschläge für die Wandbefestigung sind ausschließlich für Wände aus Beton oder Vollziegeln geeignet. Sollten die heimischen Wände aus anderem Baumaterial bestehen oder sollte es Zweifel in Hinsicht auf dieses Baumaterial geben, bitte eine Fachkraft zu Rate ziehen.

FR.

ATTENTION! Ce meuble doit être fixé en permanence au mur pour éviter les risques de chute. L'ensemble comprend des moyens de fixation adaptés uniquement aux murs de béton ou de brique. Si votre mur est fait d'un matériau différent ou si vous êtes incertain quant à la construction du mur, consultez un spécialiste.

I.

ATTENZIONE! Il mobile deve essere permanentemente fissato alla parete per evitare i rischi derivanti da un ribaltamento del mobile.

La confezione contiene solo elementi di fissaggio adatti per pareti in calcestruzzo o in laterizio pieno. Se la vostra parete è realizzata in materiale diverso o avete dubbi sulla costruzione della parete, consultare uno specialista per un montaggio corretto.

RU.

ПРИМЕЧАНИЕ! Эту мебель необходимо всегда прикреплять к стене, чтобы избежать рисков, связанных с переворотом мебели. В пакете находятся крепежные элементы, которые подходят исключительно к бетонным стенам или из целого кирпича. Если стена изготовлена из другого материала или Вы не уверены относительно строения стены, проконсультируйтесь относительно монтажа со специалистом.

EN.

WARNING! To prevent this furniture from tripping over, fix it to the wall permanently. The package includes fastening elements only suitable for concrete or full-brick walls. If your wall is made of a different material or you are unsure as to the construction of the wall, please consult a specialist regarding installation.

SK.

POZOR! Nábytok musí byť trvalo pripevnený k stene tak, aby sa zamedzilo riziku prevrátenia. V balíku sa nachádzajú upevňovacie komponenty výlučne pre betónové steny alebo steny z plnej tehly. Ak je Vaša stena z iného materiálu alebo ak si nie ste istí, z čoho je stena vyhotovená, vyžiadajte si odbornú pomoc.

CZ.

POZOR! Nábytek je nutné pevně připevnit ke zdi, abychom se vyhnuli riziku spojenému s jeho převrnutím. V balíčku se nacházejí připevňující prvky vhodné výhradně do betonových zdí nebo zdí z plných cihel. Pokud jsou Vaše zdi zhotoveny z jiného materiálu nebo si nejste jejich konstrukci jisti, konzultujte otázku montáže se specialistou.

RO.

ATENȚIE! Mobilă trebuie ancorată permanent în perete pentru a evita riscul de răsturnare a mobilei. Pachetul conține elementele de fixare potrivite numai pentru pereții din beton sau din cărămidă solidă. Dacă peretele Dvs. este realizat dintr-un alt material sau nu sunteți sigur care este structura peretelui, consultați un specialist în privința montajului.

NL.

OPMERKING! De meubelen moeten permanent aan de muur worden bevestigd om te voorkomen dat de meubelen kantelen. Het pakket bevat bevestigingselementen die alleen geschikt zijn voor betonnen of massieve bakstenen muren. Als uw muur van een ander materiaal is gemaakt of als u niet zeker bent over de constructie van deze muur, raadpleeg dan een specialist voor de installatie.

TR.

DİKKAT! Devrilmeye riskini önlemek için mobilya duvara sabitlenmelidir. Pakette, sadece beton veya tam tuğla duvarlara uygun sabitleme elemanları bulunmaktadır. Eğer duvarınız başka bir malzemedir yapıldıysa veya duvar yapısından emin değilseniz, montaj konusunda bir uzmana danışınız.

E.

¡ATENCIÓN! El mueble debe ser fijado permanentemente a la pared para evitar el riesgo relacionado con el vuelco del mueble. En el paquete hay elementos de fijación adecuados solo para paredes de hormigón o de ladrillo entero. Si su pared está hecha de otro material o no está seguro sobre la construcción de esta pared, consulte el montaje con un especialista.

CN.

注意！本家具需要固定在墙上以免倒塌。本包所含有的固定部件仅适用于混凝土墙及整砖墙。欲使用在其他墙体或不确定墙体时，请向专家询问安装方式。

HR.

NAPOMENA! Namještaj mora biti trajno pričvršćen za zid, kako bi se izbjegao rizik od njegova prevrtanja. U paketu se nalaze elementi za pričvršćivanje prikladni isključivo za betonske zidove ili punu ciglu. Ako je Vaš zid izrađen od drugog materijala ili niste sigurni od čega je napravljen Vaš zid, konzultirajte se sa stručnjakom u vezi sa montažom.

SLO.

POZOR! Pohištvo trajno pritrđite na steno, da preprečite tveganje, da se prevrne. V paketu so pritrđilni elementi, ki so ustrezni izključno za betonske stene in za stene iz polne opeke. Če je vaša stena izdelana iz drugih materialov ali niste gotovi glede konstrukcije stene, se o montaži posvetujte s strokovnjakom.

HU.

FIGYELEM! Rögzítse a bútorokat a falhoz, hogy elkerülje a bútor felborulásának kockázatát. A készletben kizárólag beton- vagy téglafalhoz használható kötőelemek találhatóak. Ha a fal más anyagból készült, vagy ha nem tudja, milyen falak találhatóak otthonában, forduljon szakemberhez.

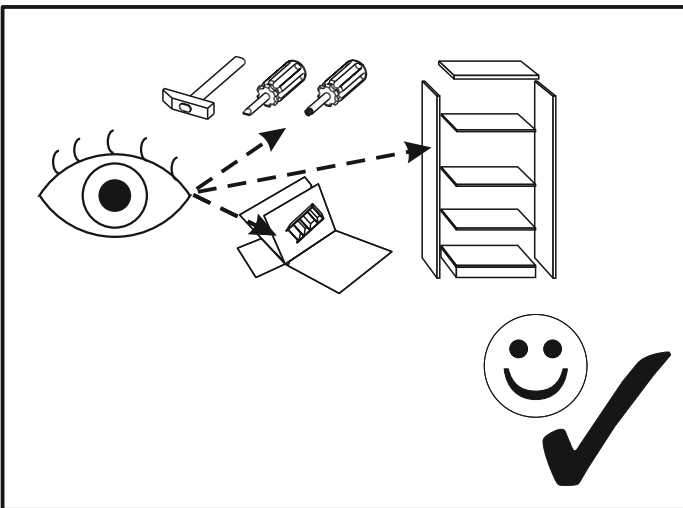



version A

BCxx

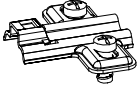

BCxx

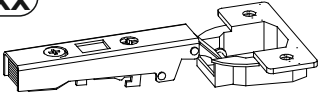

BRx



BRx

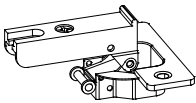

version B

BCxx + BCxx

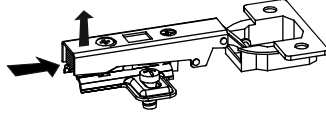

BCxx

BCxx

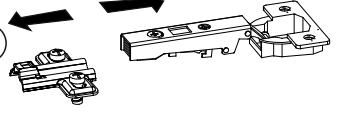

BRx + BRx

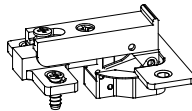

BRx



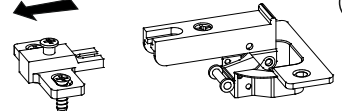

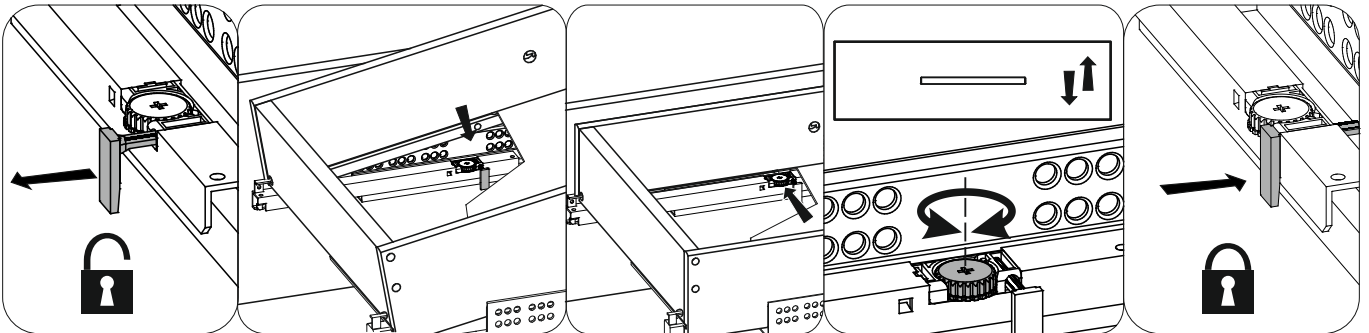
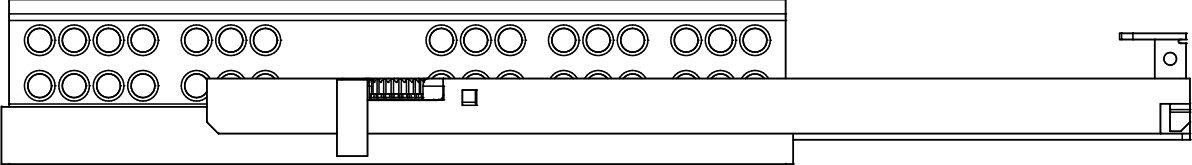
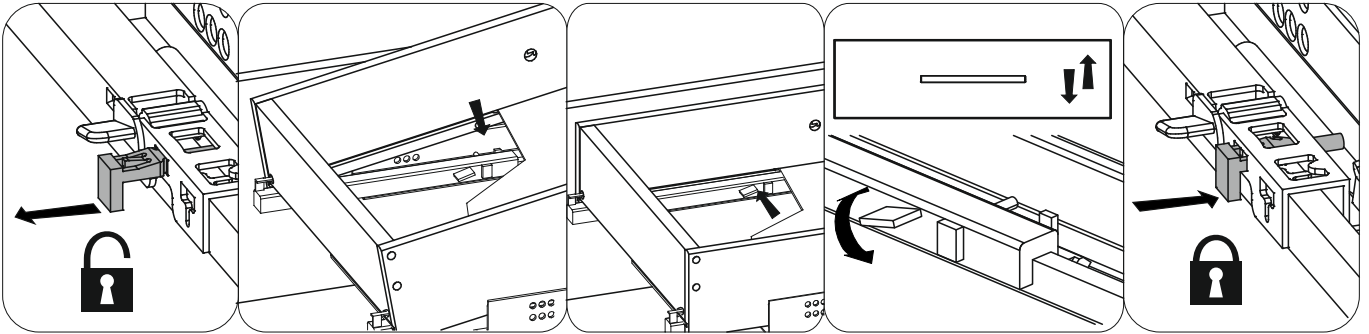
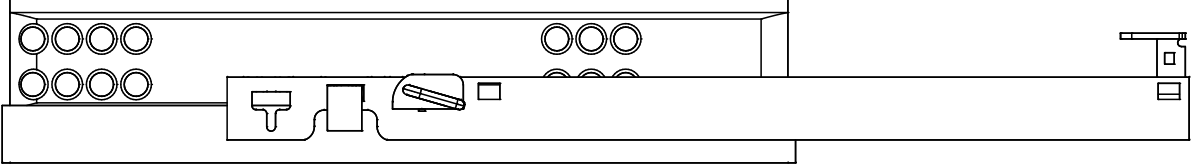
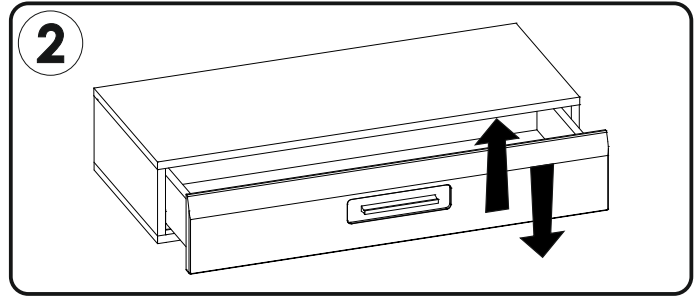
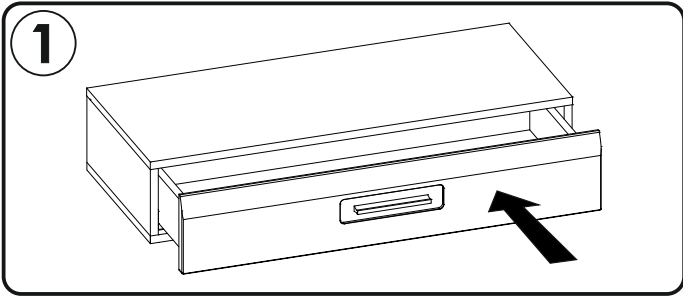



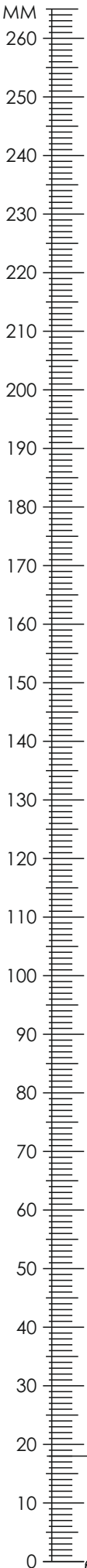



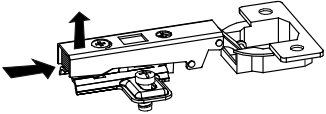
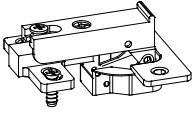
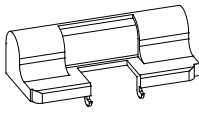

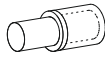
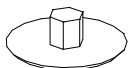

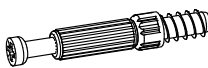
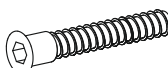
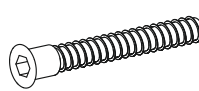
BRx



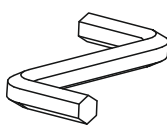

SAIF02

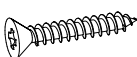
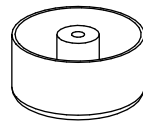

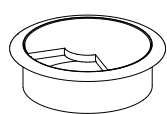
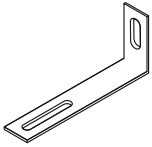
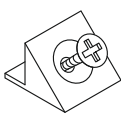
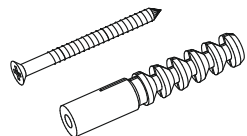
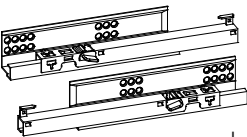
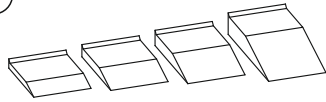
A1 8 x 35 mm x44 	A6 8 x 24 mm x4 	BC12 + BC11 x2 
BR2 + BR3 x2 	BR4 x2 	C2 5 x 13 mm x16 
D2 x8 	E0 Ø16 x12 	E1 15 x 12 mm x22 
F1 6 x 34 mm x22 	G1 7 x 50 mm x4 	G2 7 x 60 mm x10 
H1 L - 392mm x2 	H2 L - 84mm x2 	I2 4 x 16 mm x2 
I4 3,5 x 27 mm x6 	I5 3,5 x 27 mm x10 	M x1 
N1 3 x 16 mm x25 	N13 4 x 25 mm x7 	O1 x6 
O2A Ø20 x6 	P0 x4 	P25 x1 
Q9 x2 	R4 x16 	S13 x2  Ø8
T10 x2  L-310 mm	Z x1 	

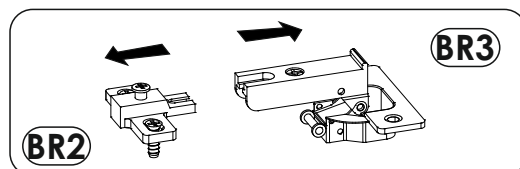
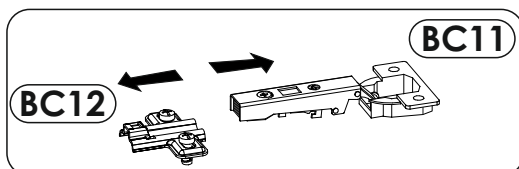

SAIF02

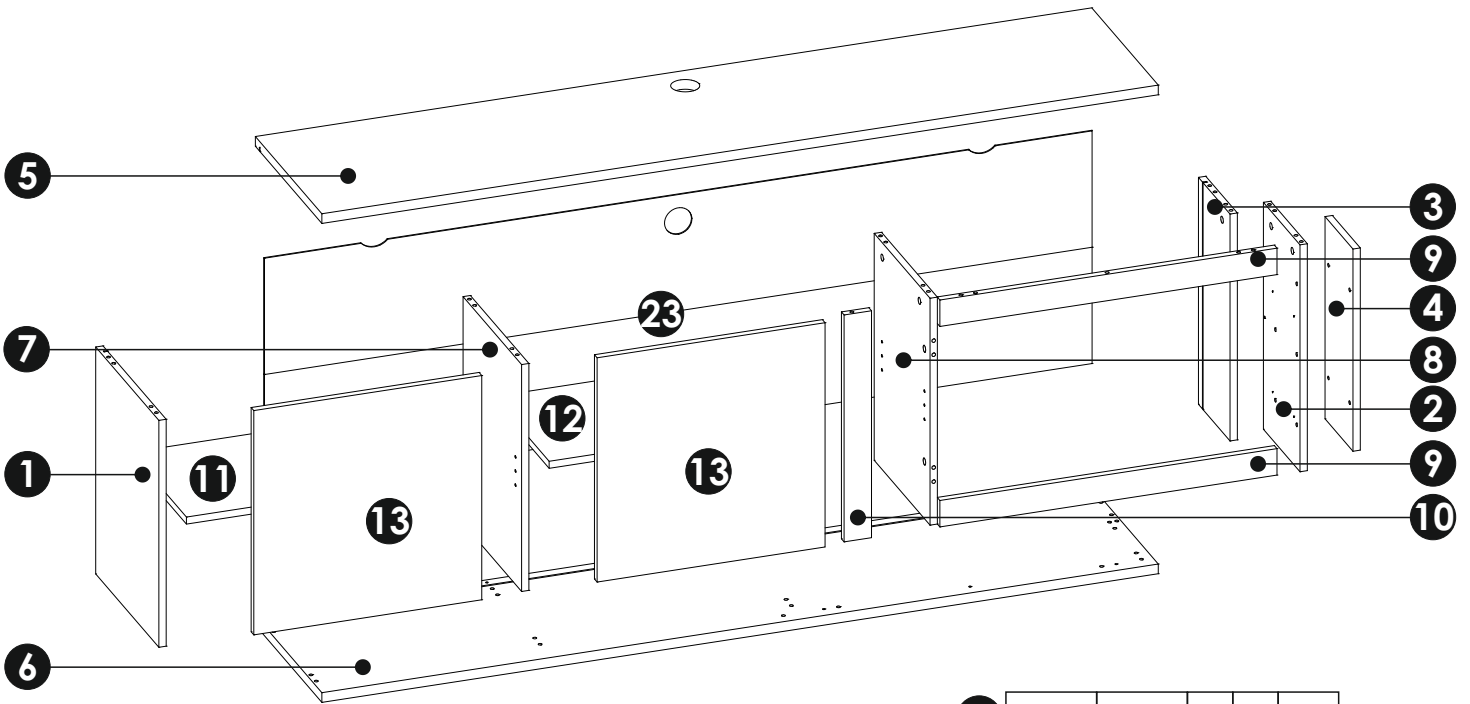
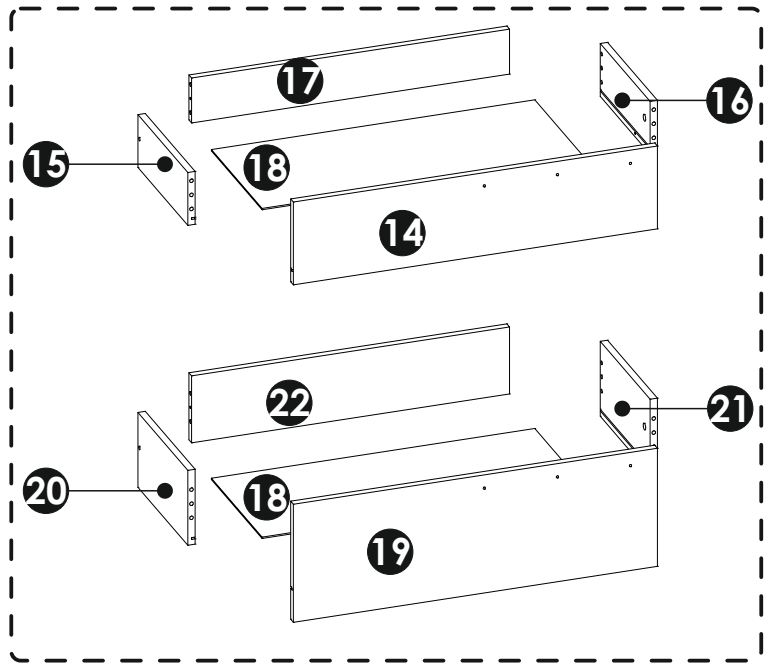
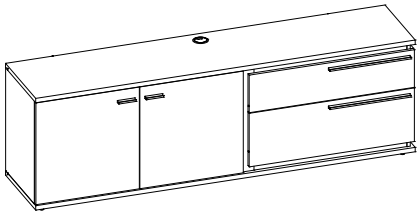

1	515	380	16	x1	1/2
2	515	220	16	x1	1/2
3	515	190	16	x1	1/2
4	168	459	16	x1	1/2
5	1831	400	22	x1	2/2
6	1831	400	22	x1	2/2
7	515	352	16	x1	1/2

8	515	336	16	x1	1/2
9	738	60	16	x2	1/2
10	515	60	16	x1	1/2
11	477	335	16	x1	2/2
12	533	335	16	x1	2/2
13	509	499	16	x2	1/2
14	797	188	16	x1	1/2

15	300	120	16	x1	1/2
16	300	120	16	x1	1/2
17	696	102	16	x1	1/2
18	708	305	3	x2	1/2
19	797	268	16	x1	1/2
20	300	170	16	x1	1/2
21	300	170	16	x1	1/2
22	696	152	16	x1	1/2
23	1812	528	3	x1	2/2

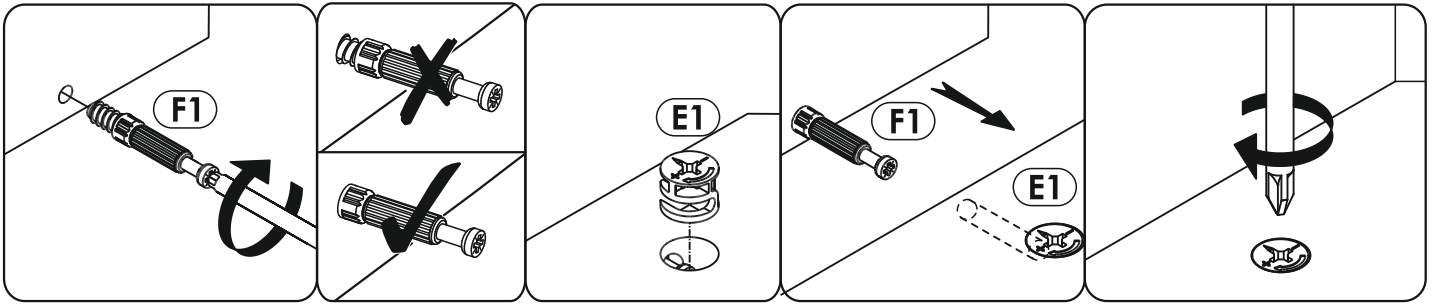

1 ▶

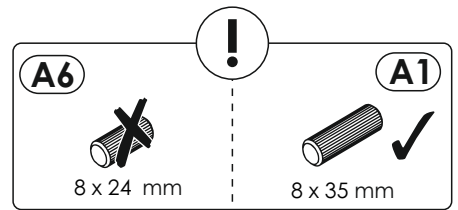
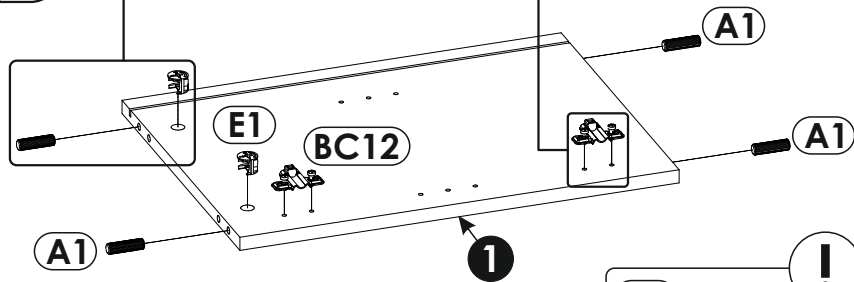
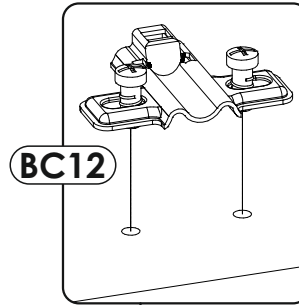
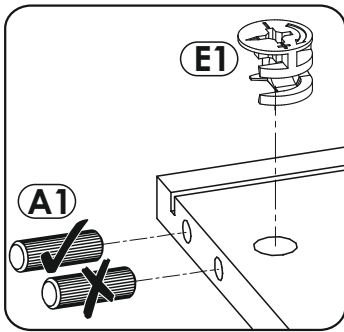
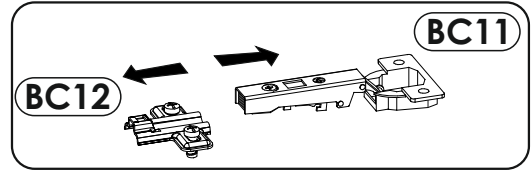
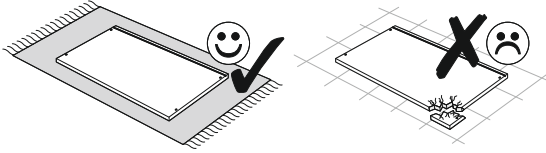

2 ▶

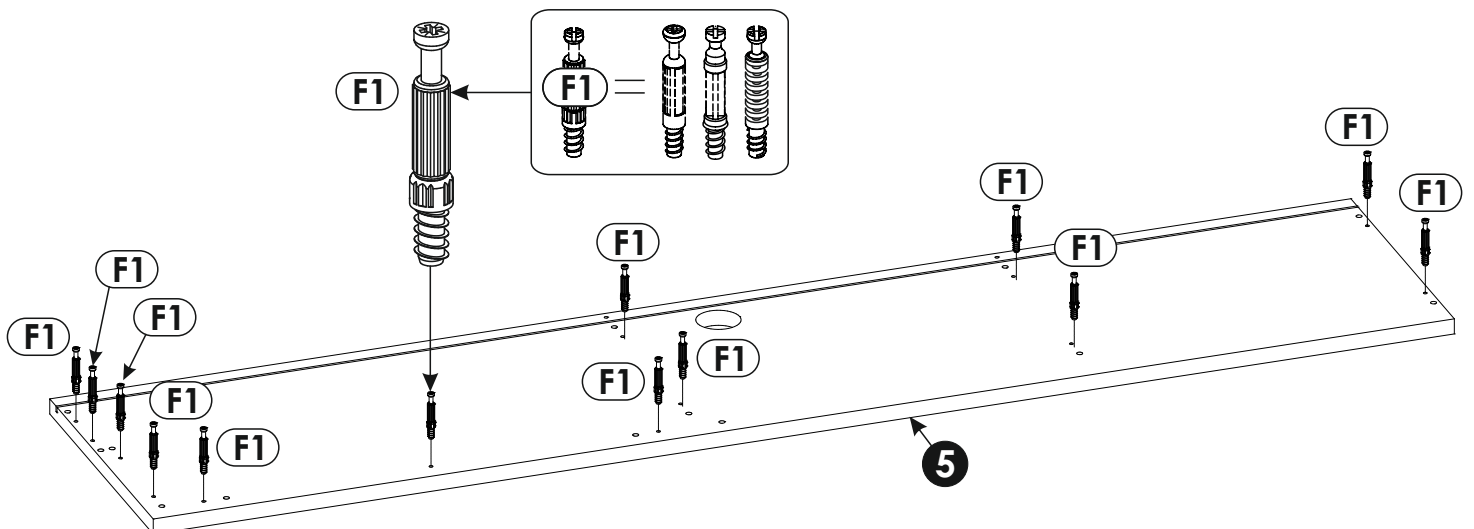
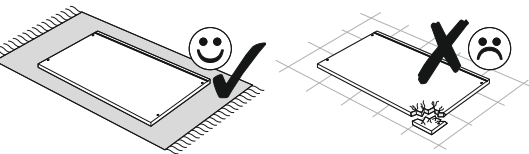

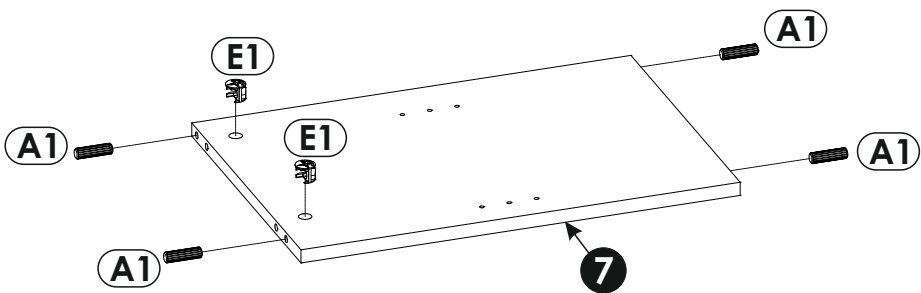
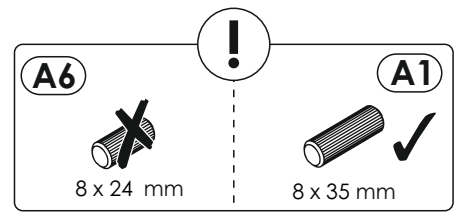
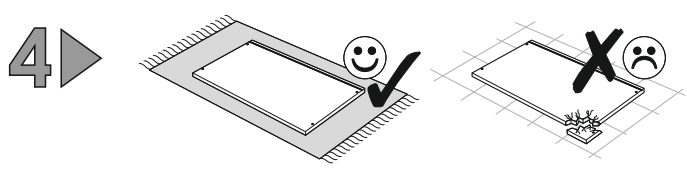
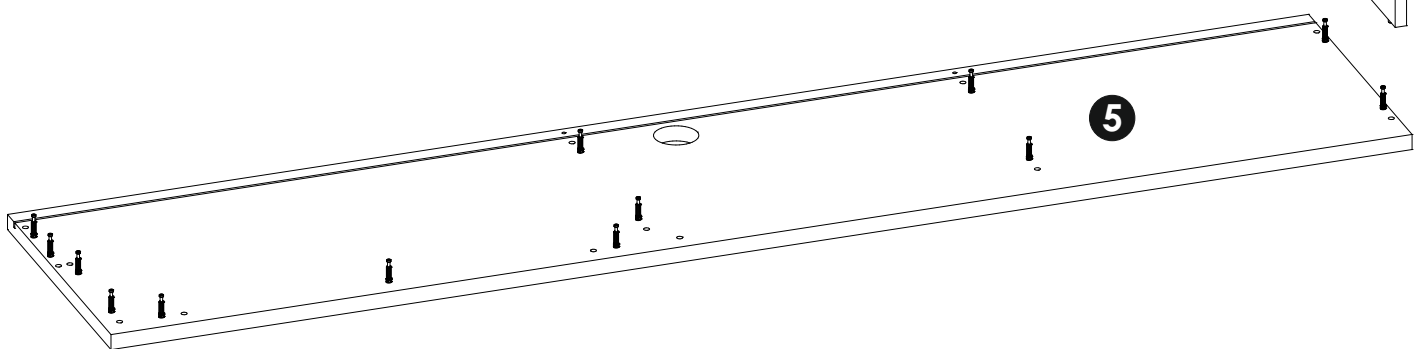
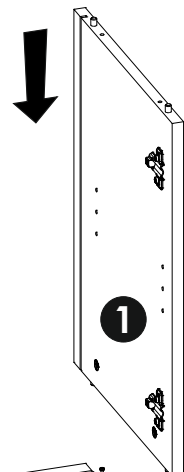
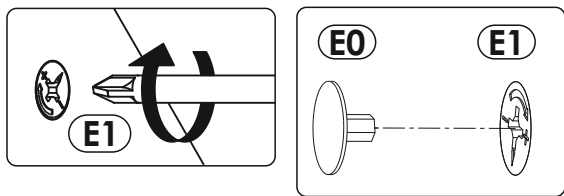
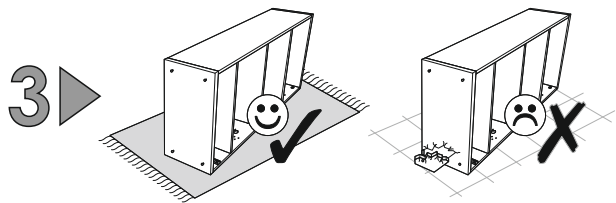

5 ▶

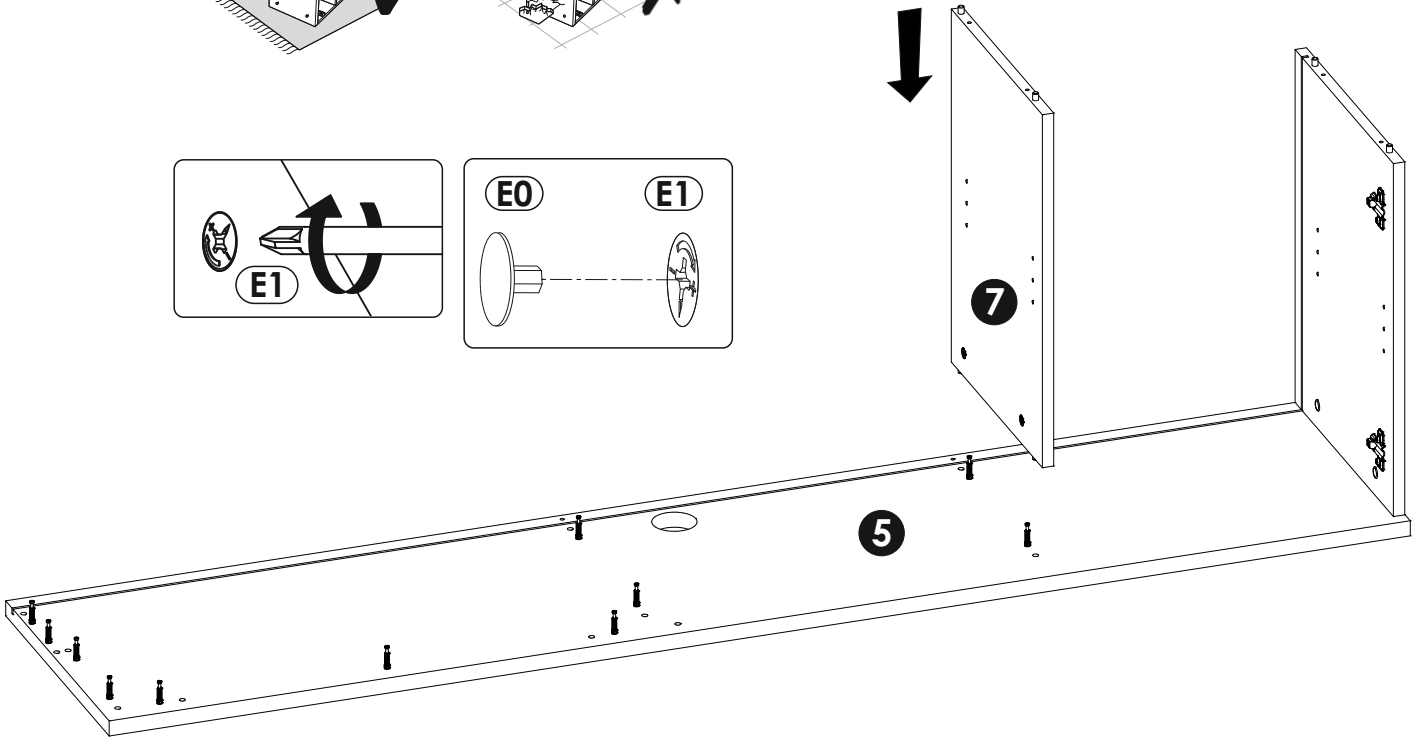
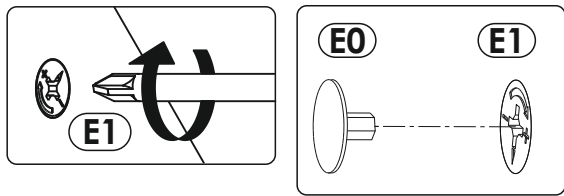
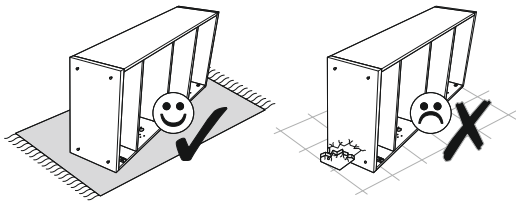

6 ▶

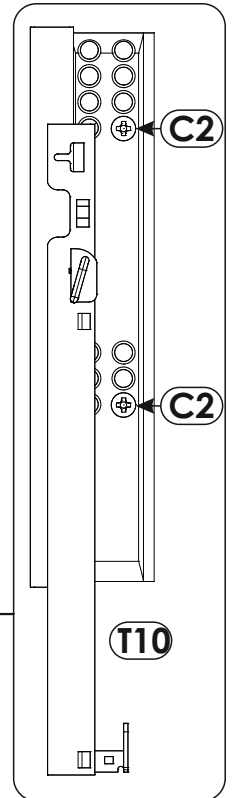
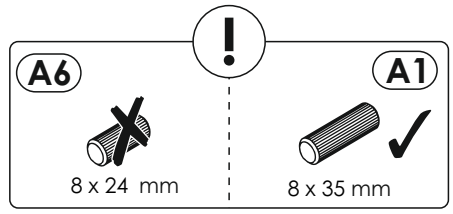
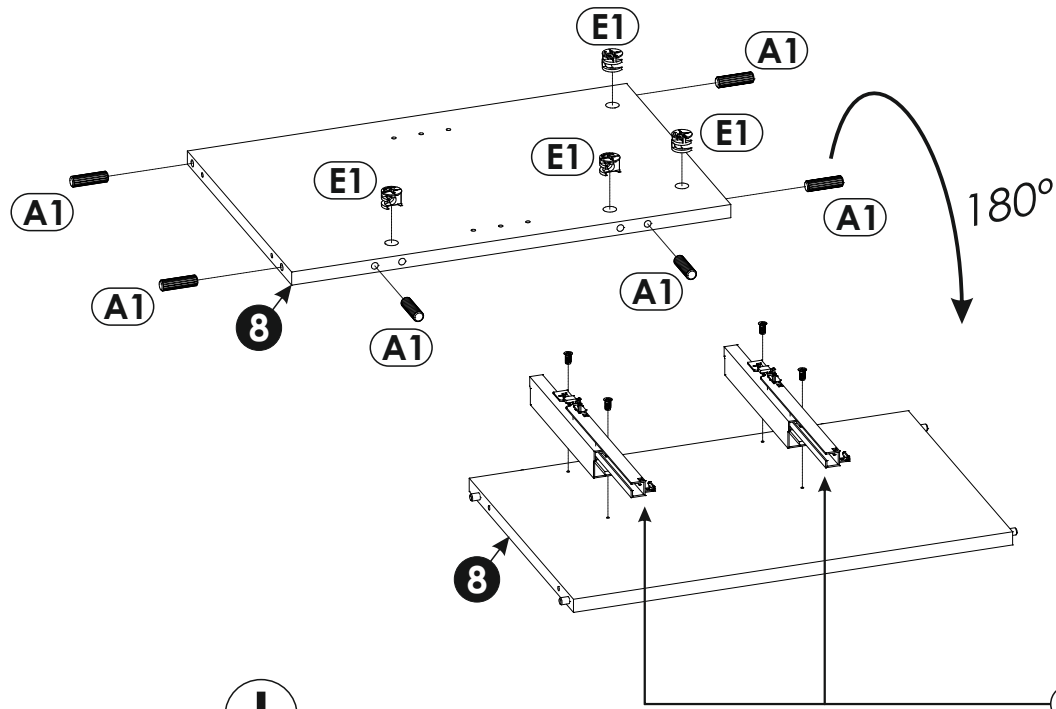
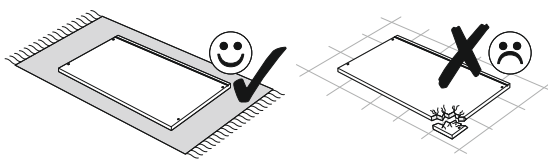

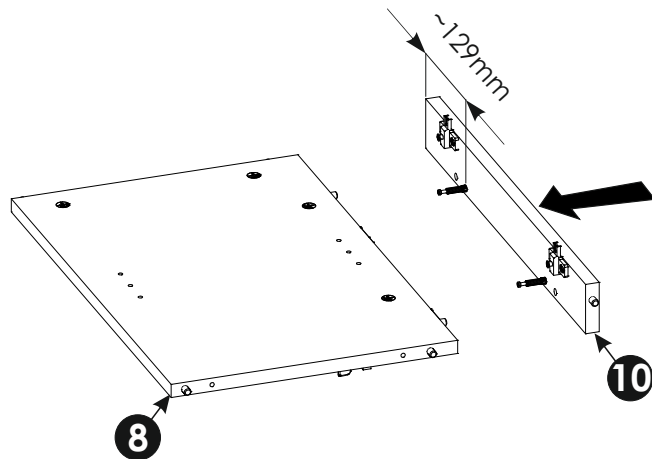
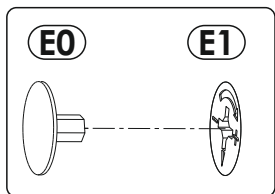
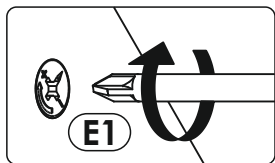
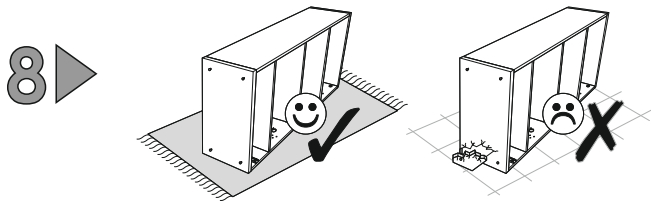
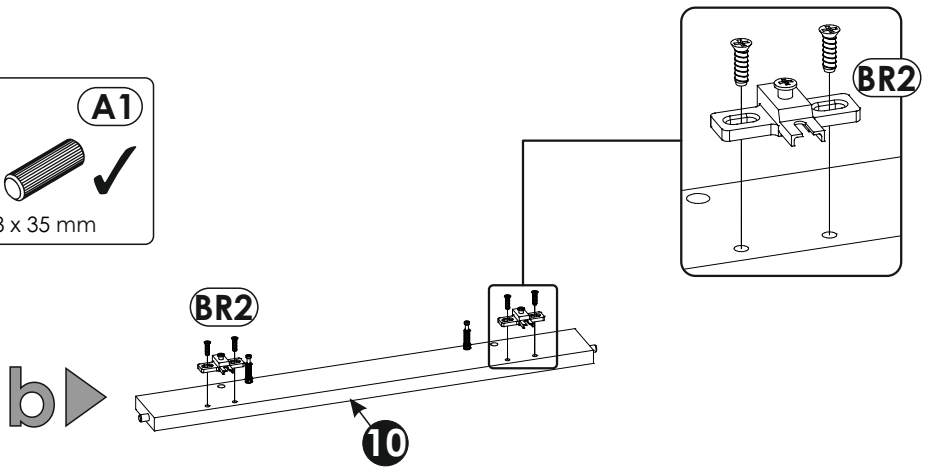
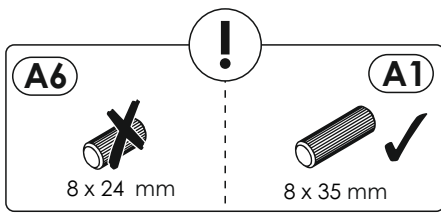
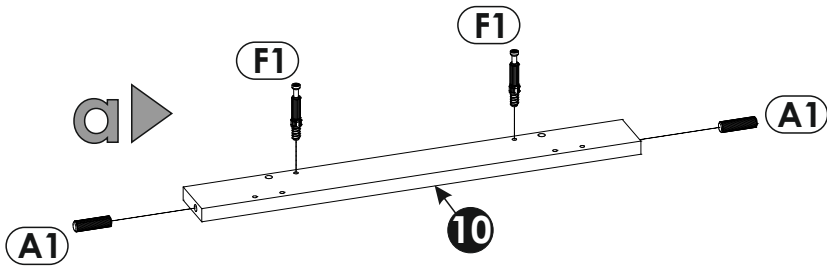
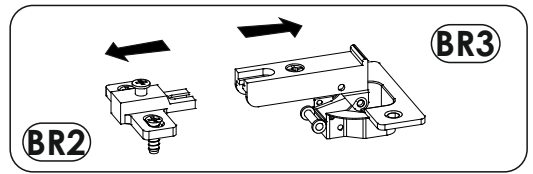
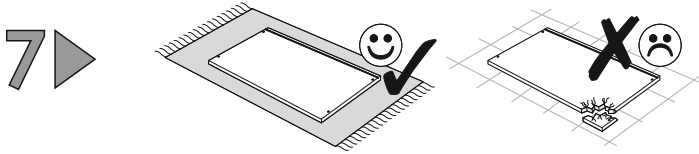

9 ▶

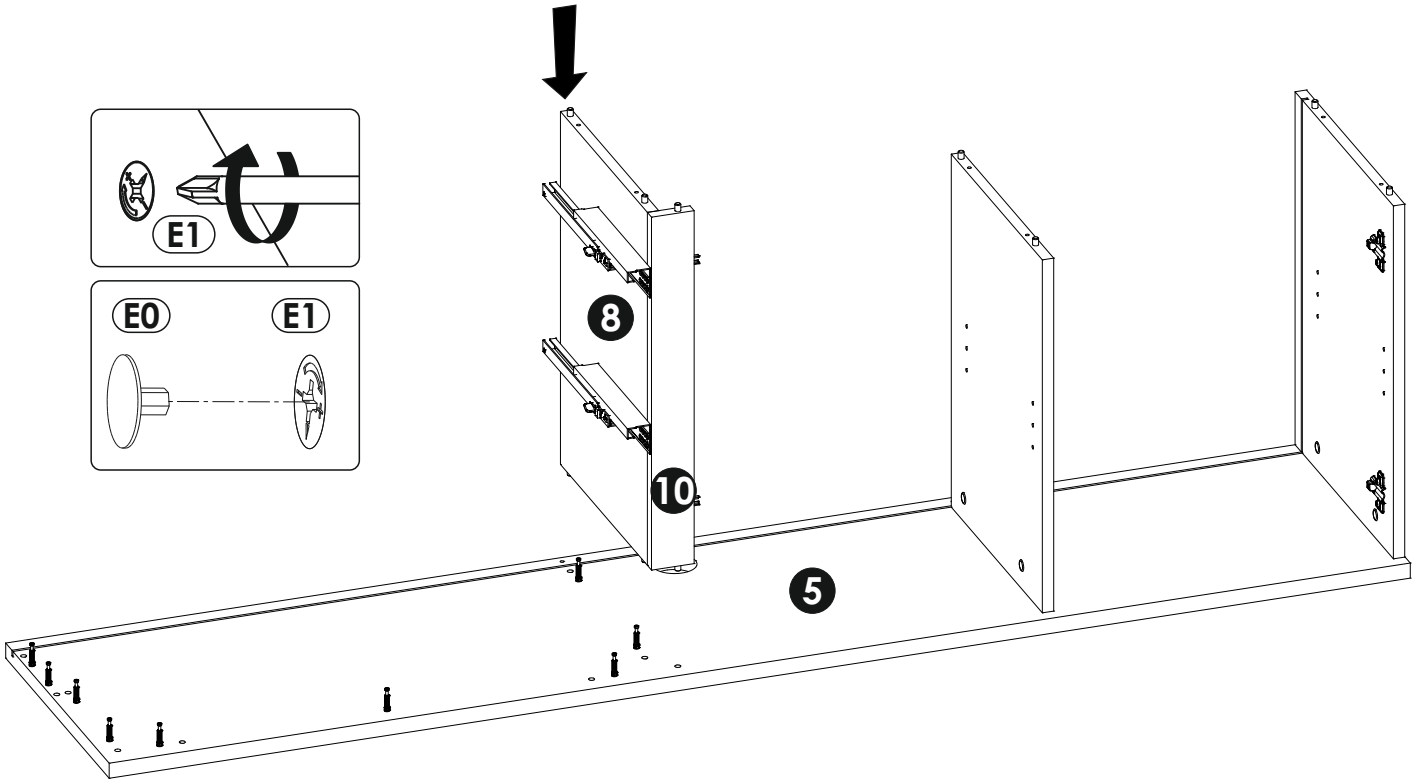
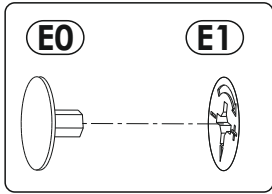
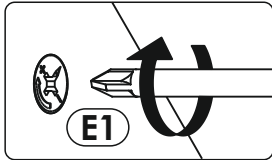
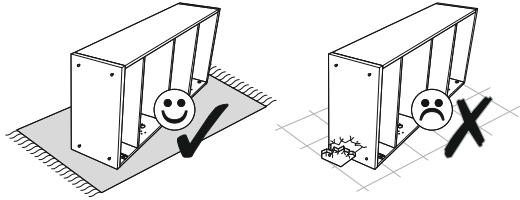

10 ▶

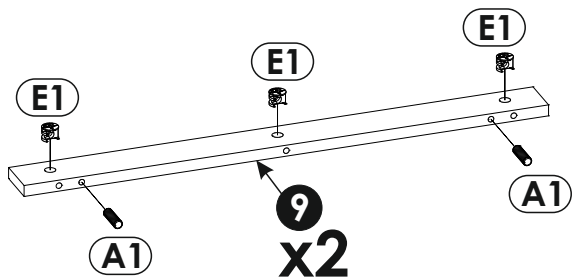
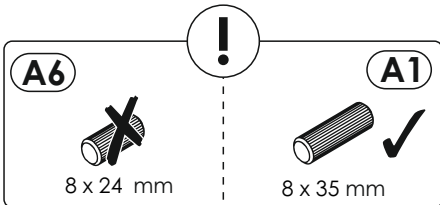
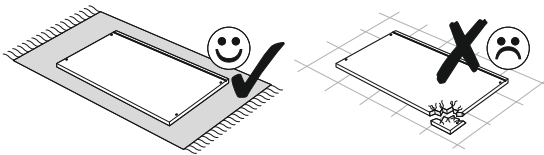

11 ▶

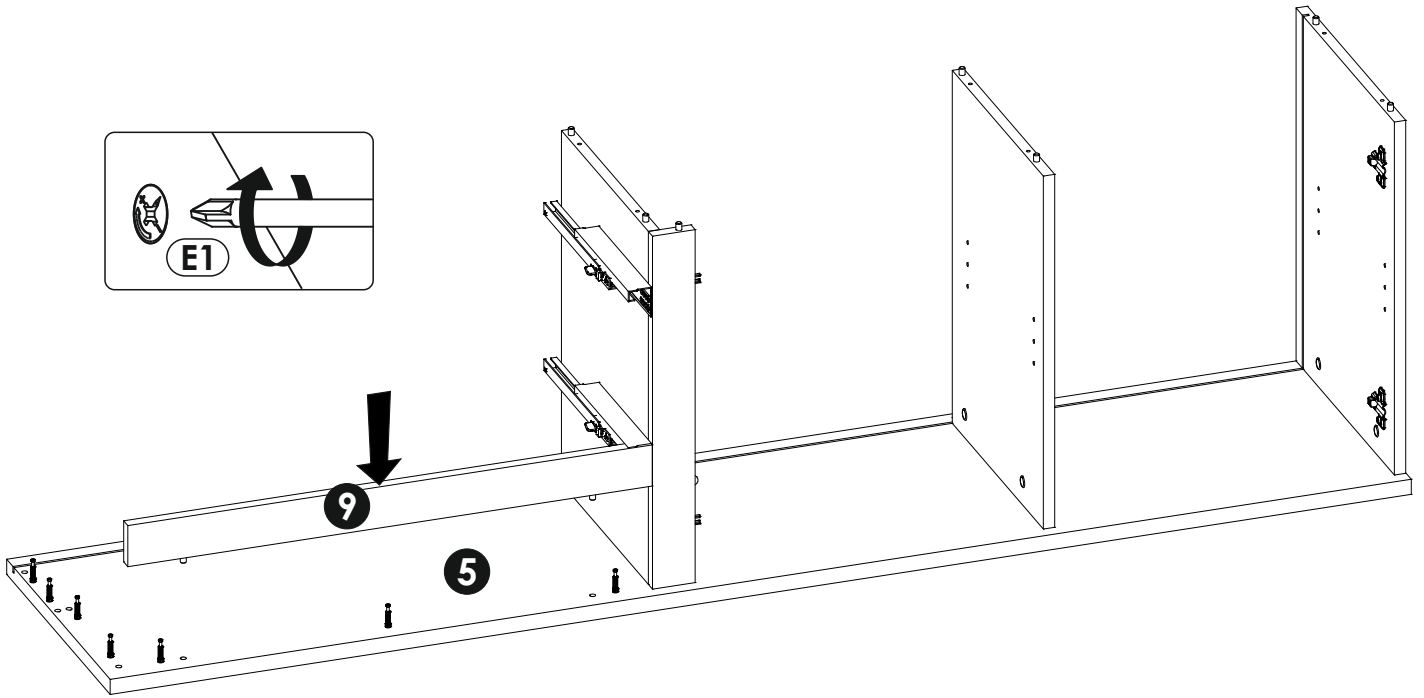
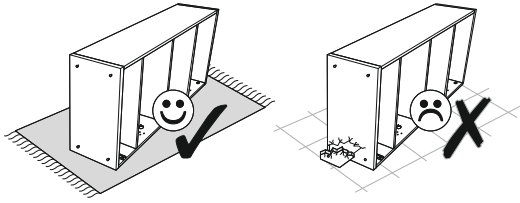

12 ▶

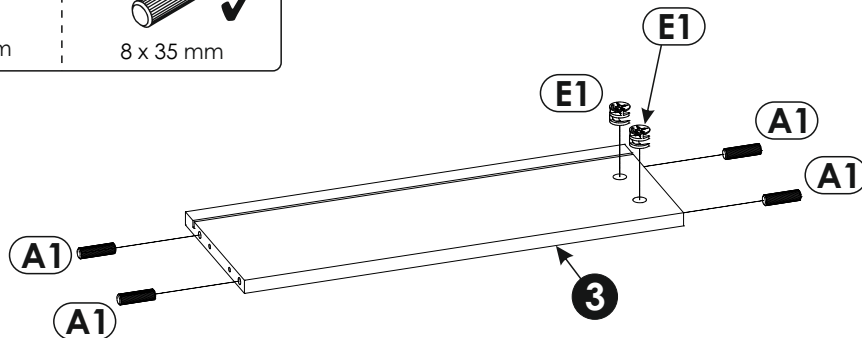
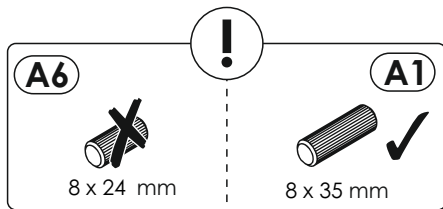
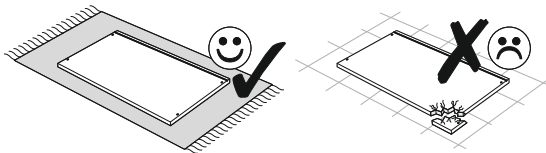

13▶

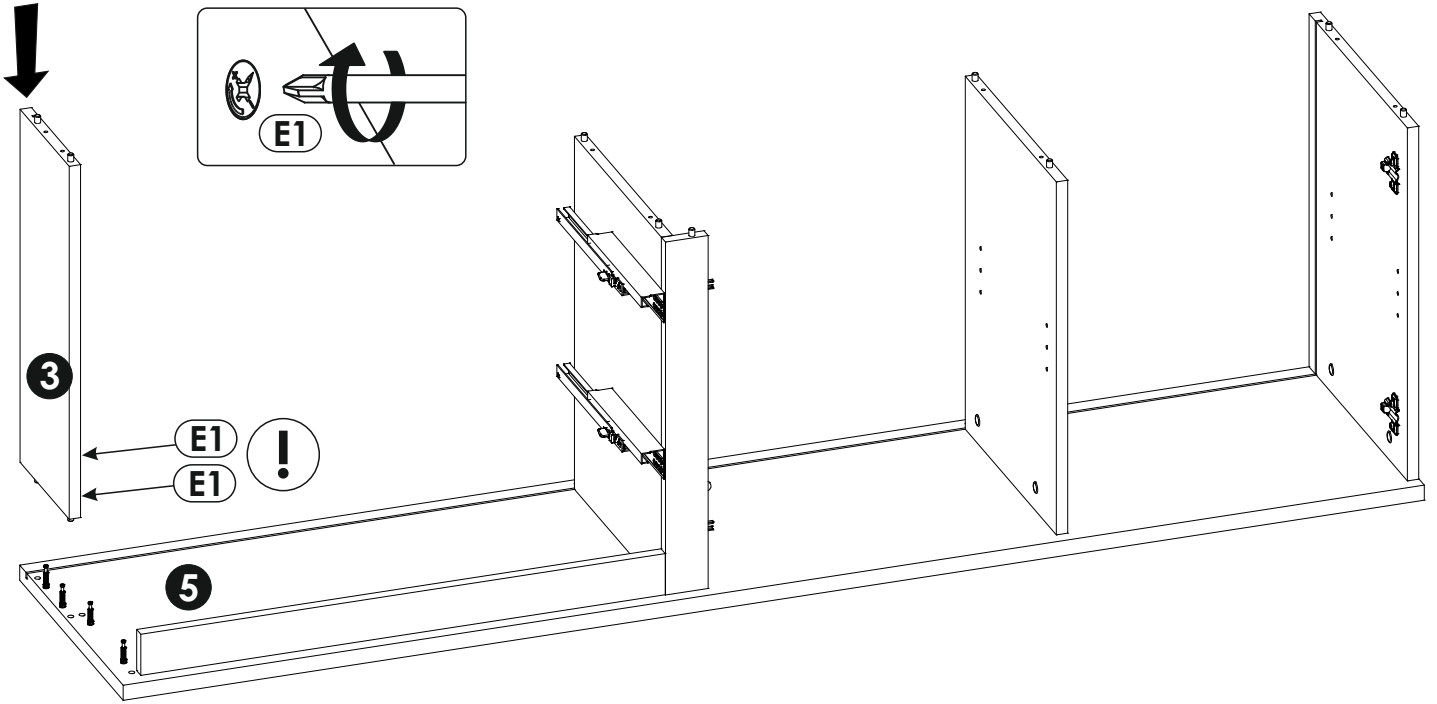
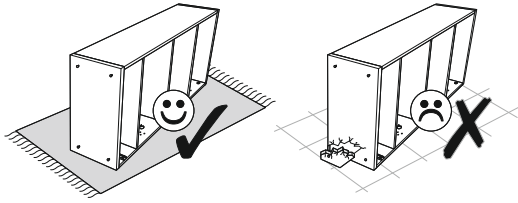

14▶

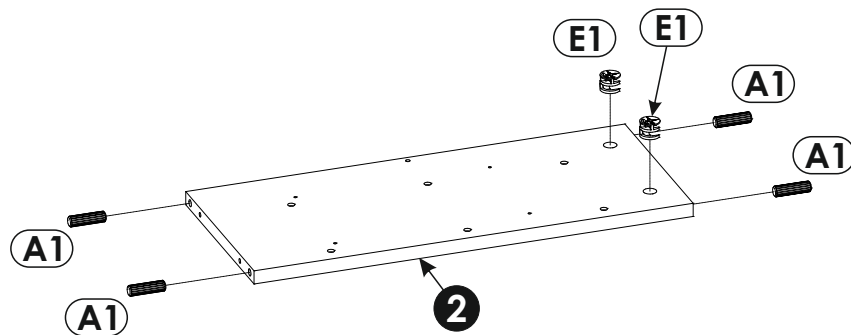
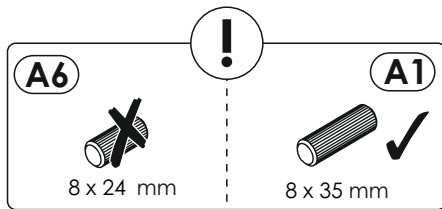
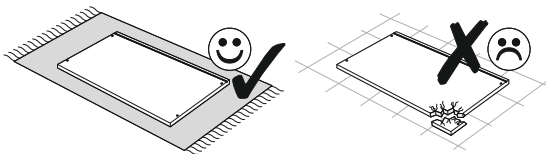

15▶

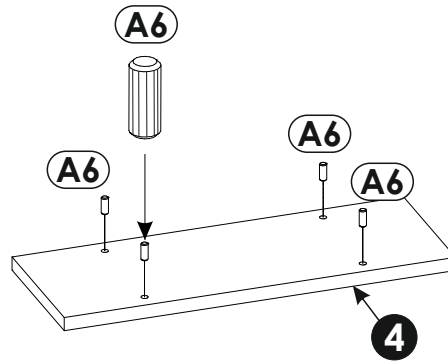
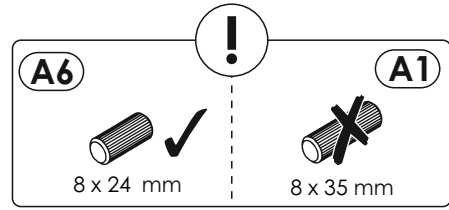
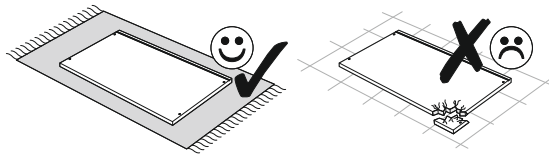

16▶

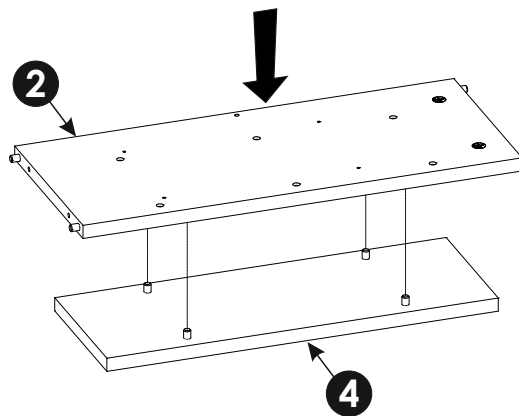
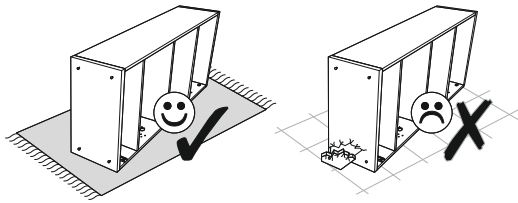

17 ▶

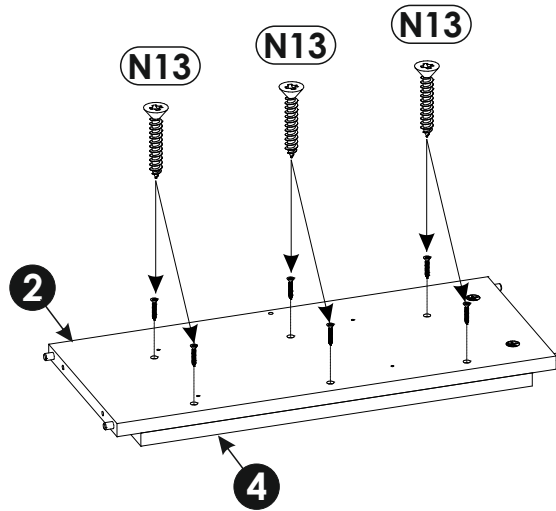
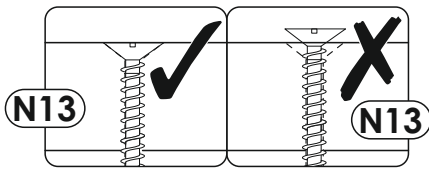
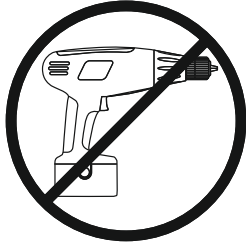
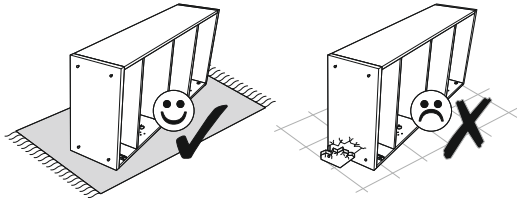

18 ▶

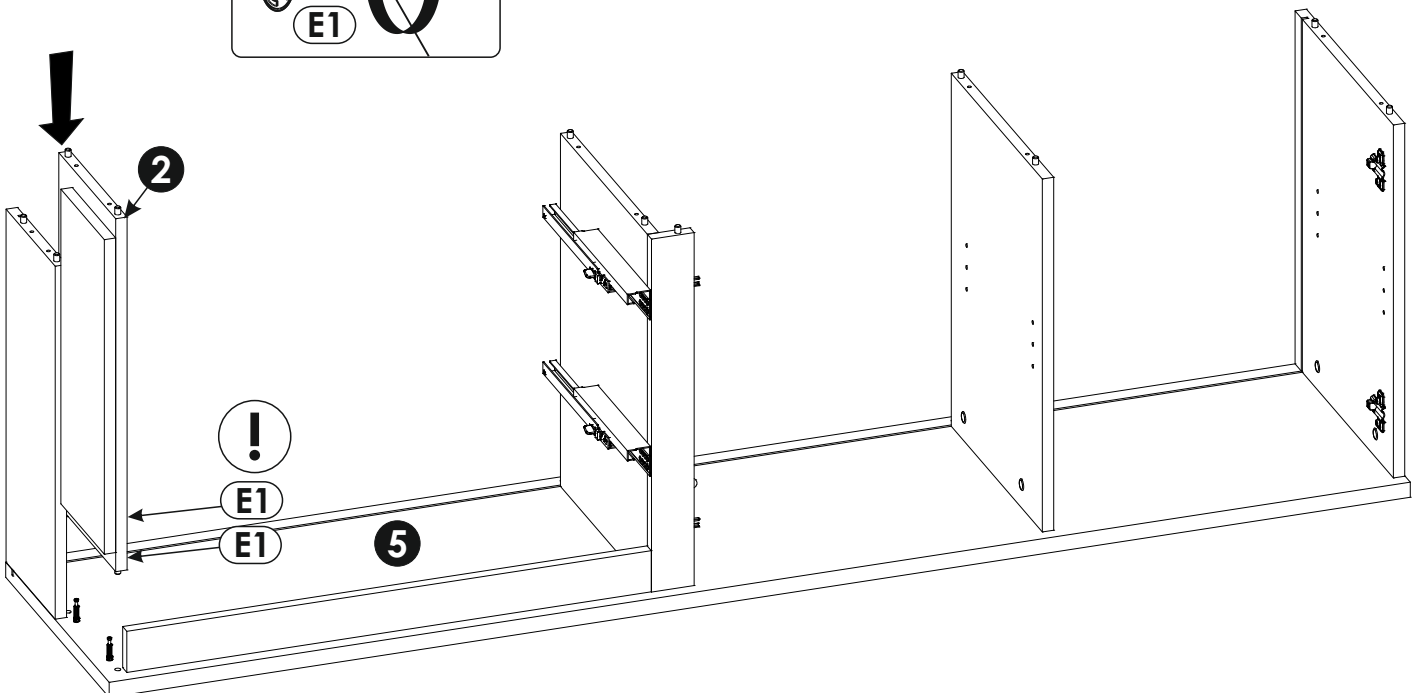
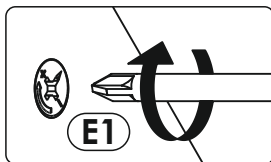
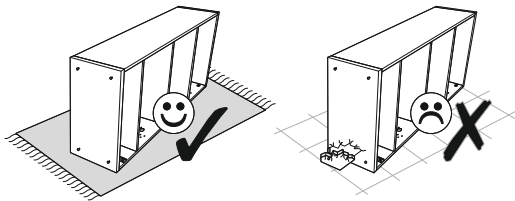

19 ▶

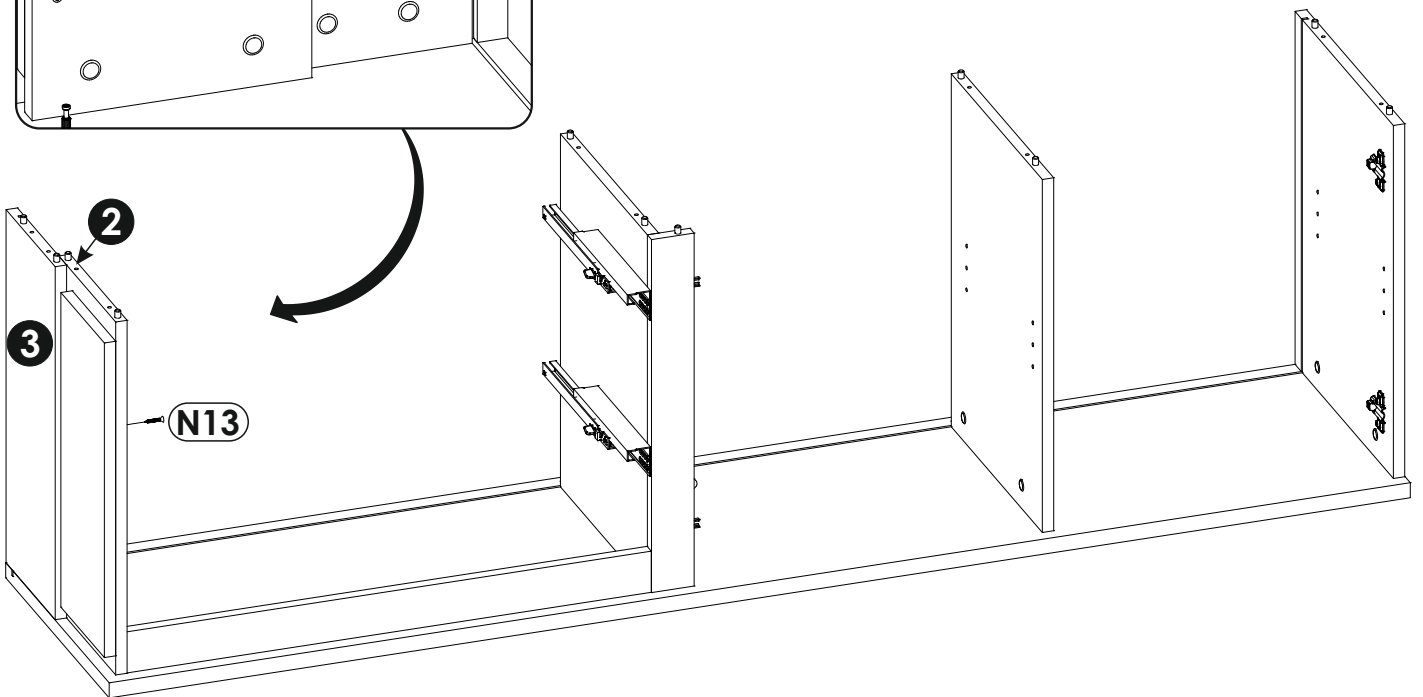
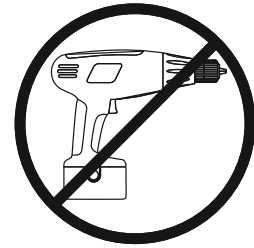
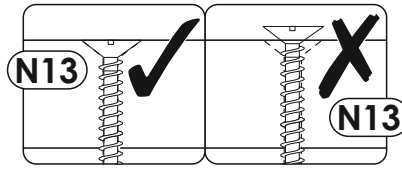
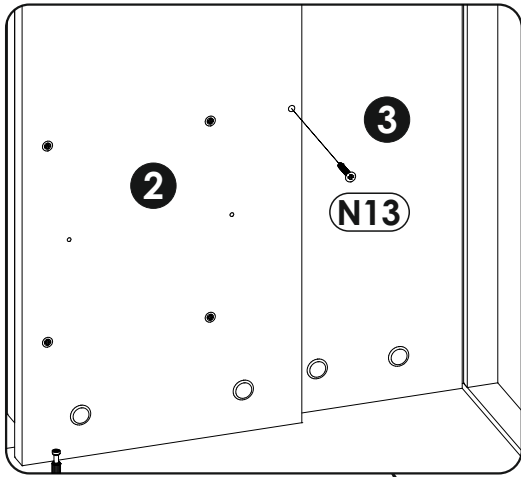
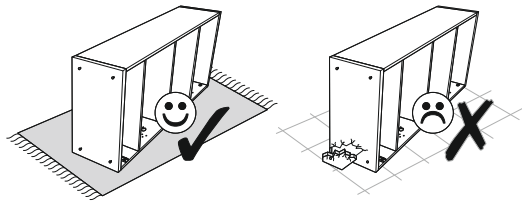

20 ▶

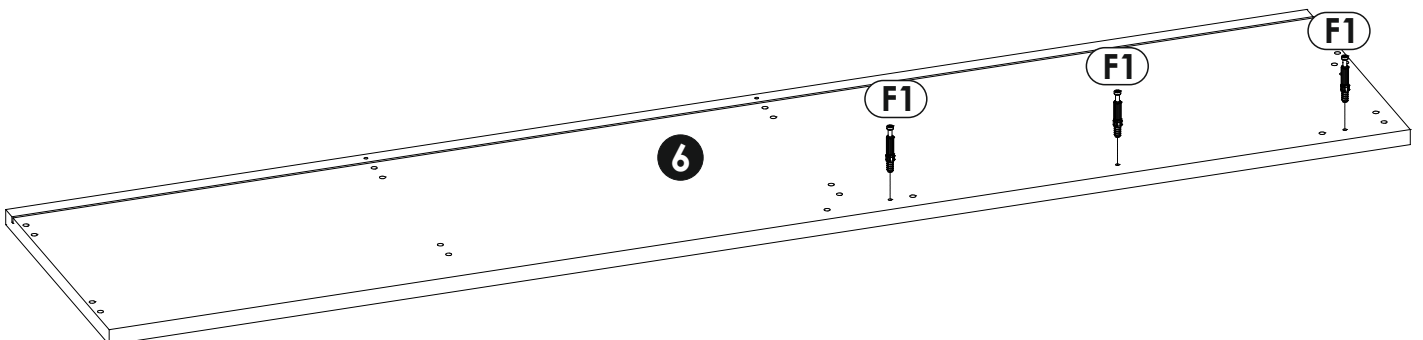
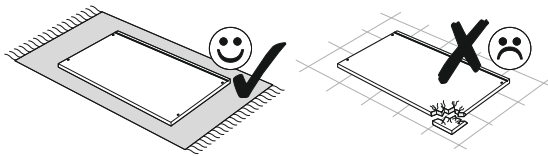

21 ▶

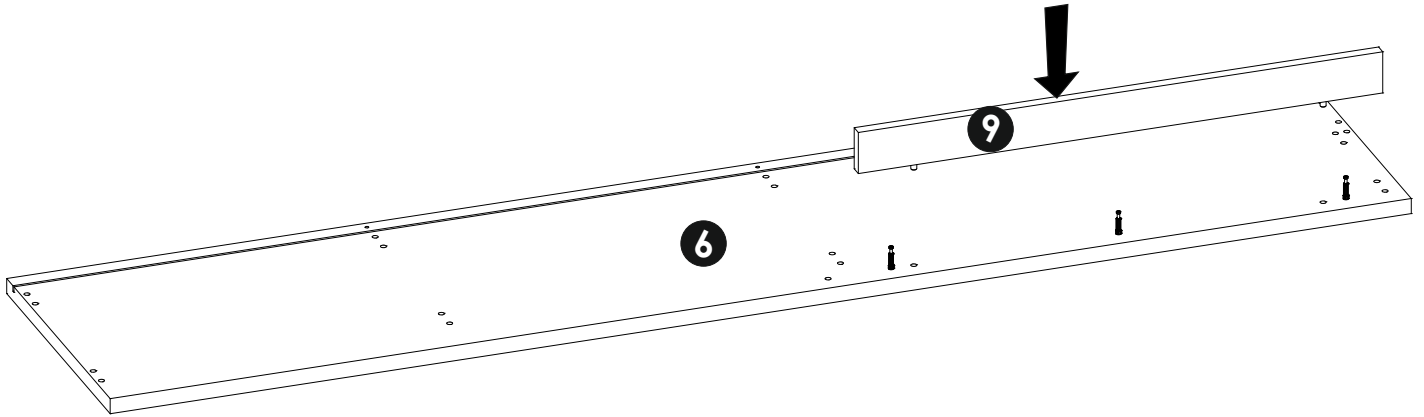
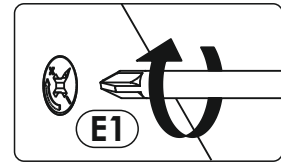
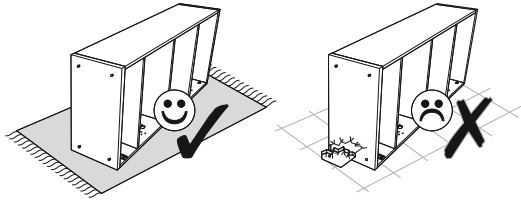

22 ▶

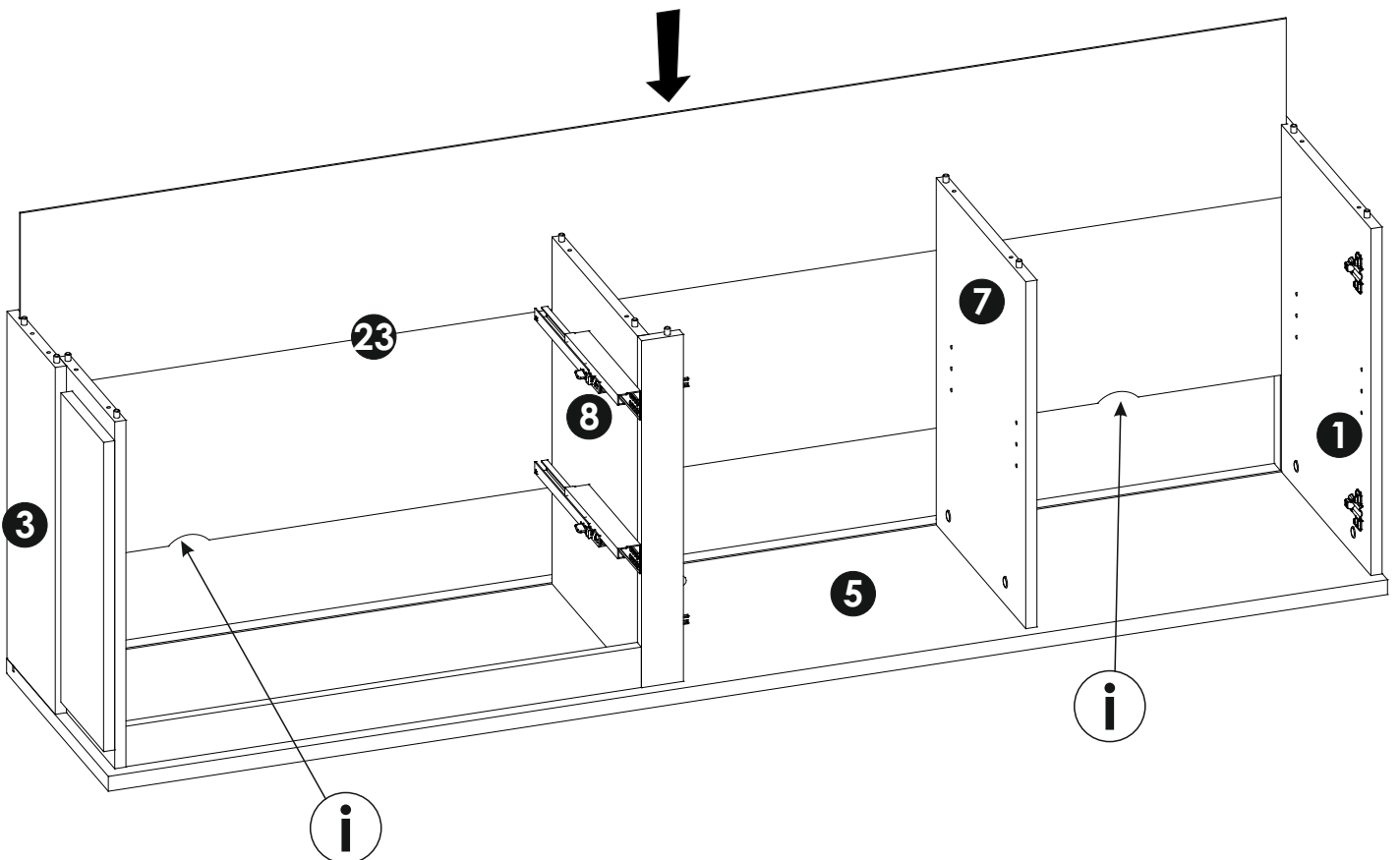
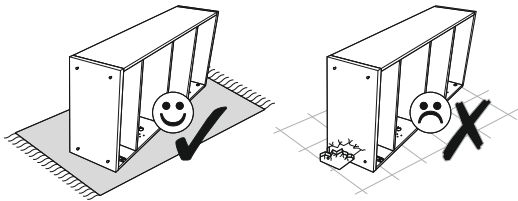

23 ▶

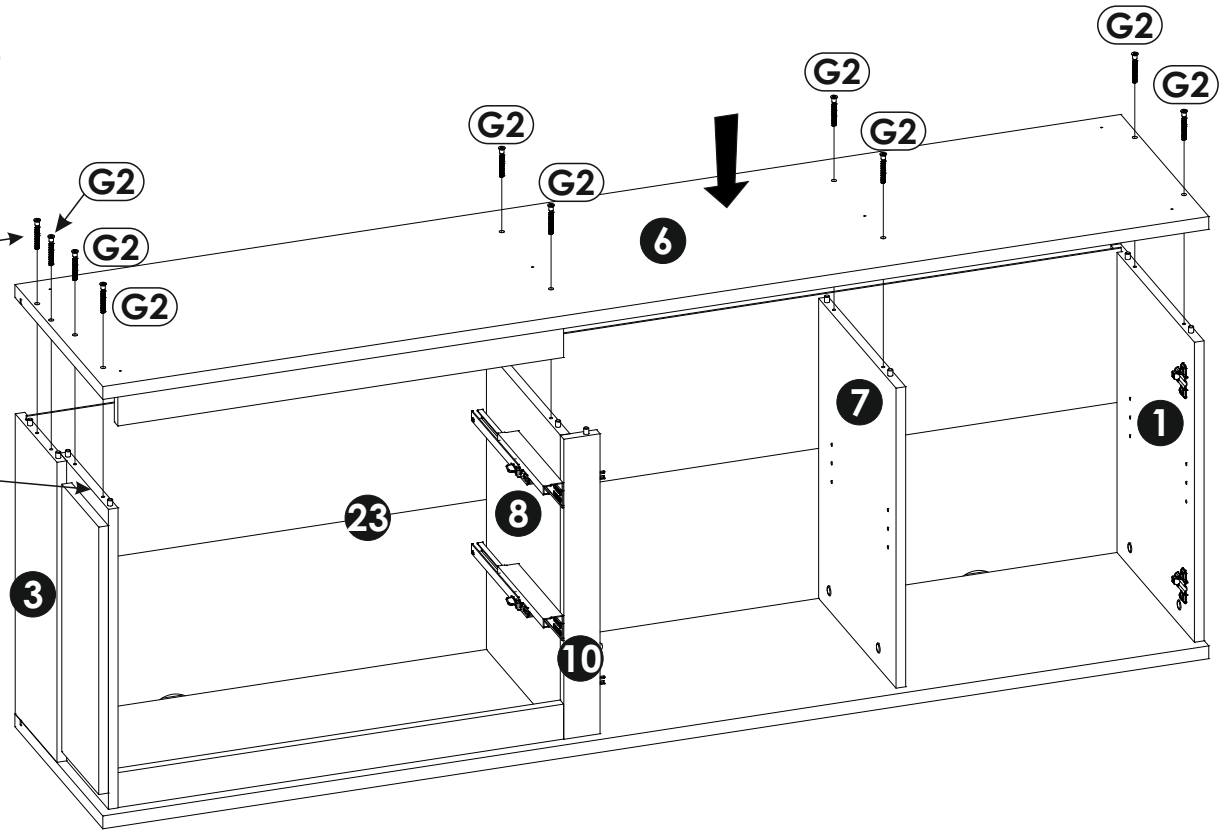
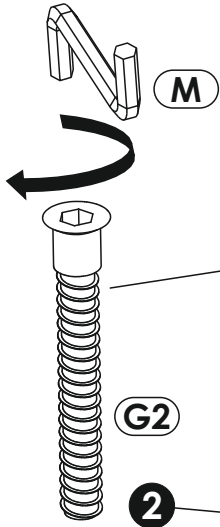
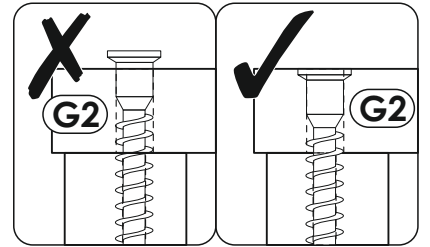
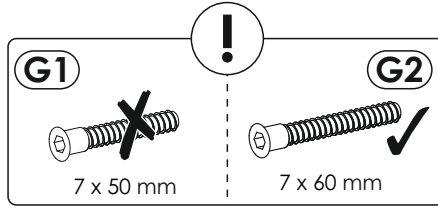
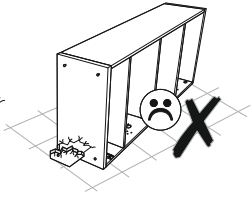
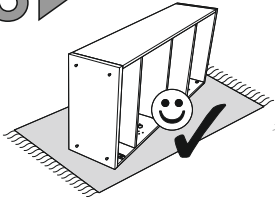

24 ▶

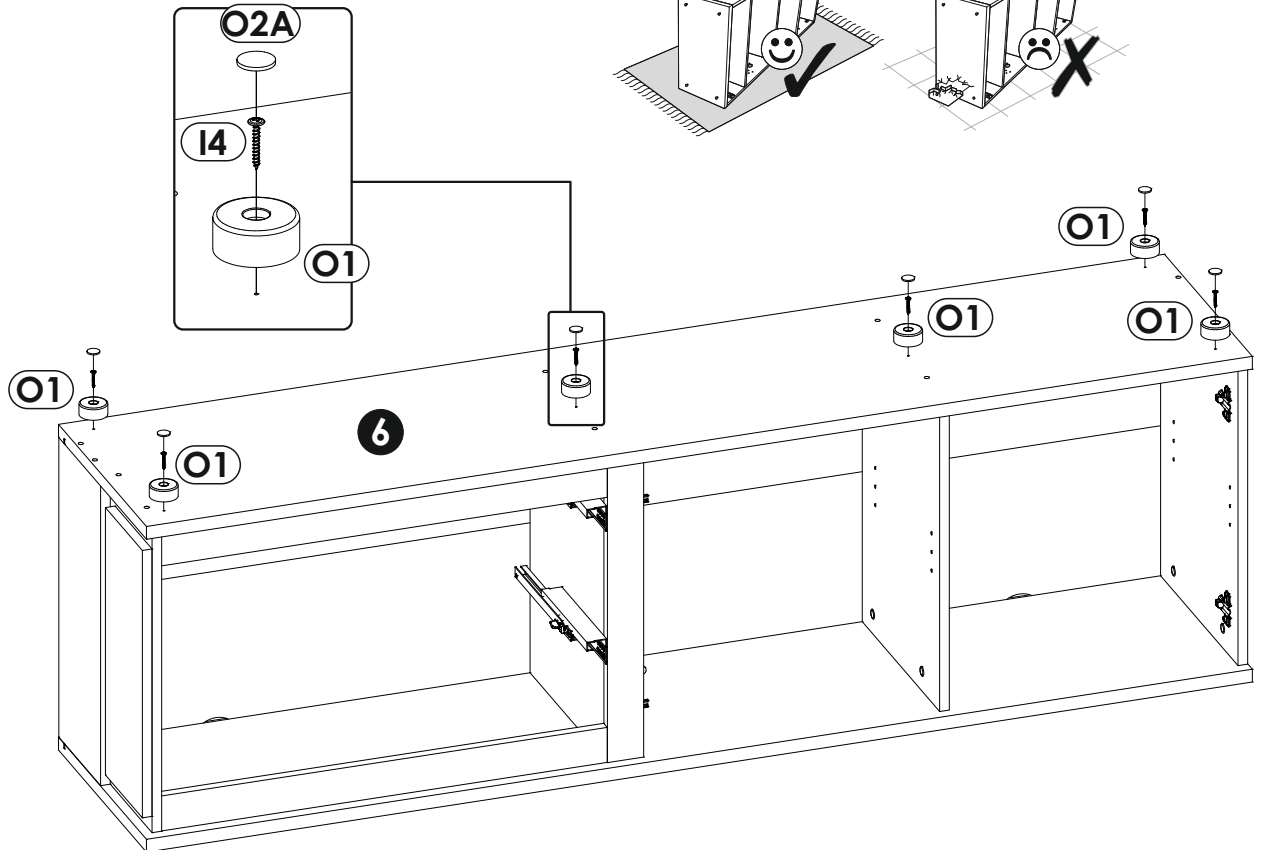
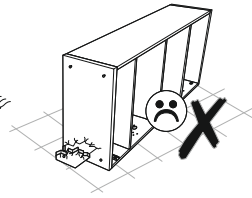
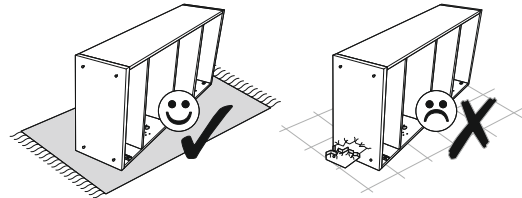

25 ▶

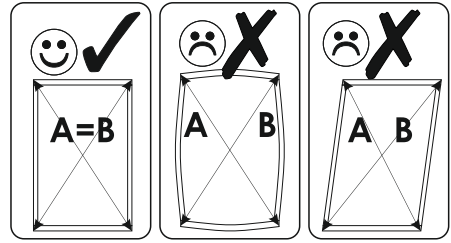
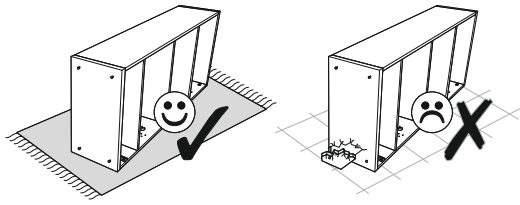

A=B

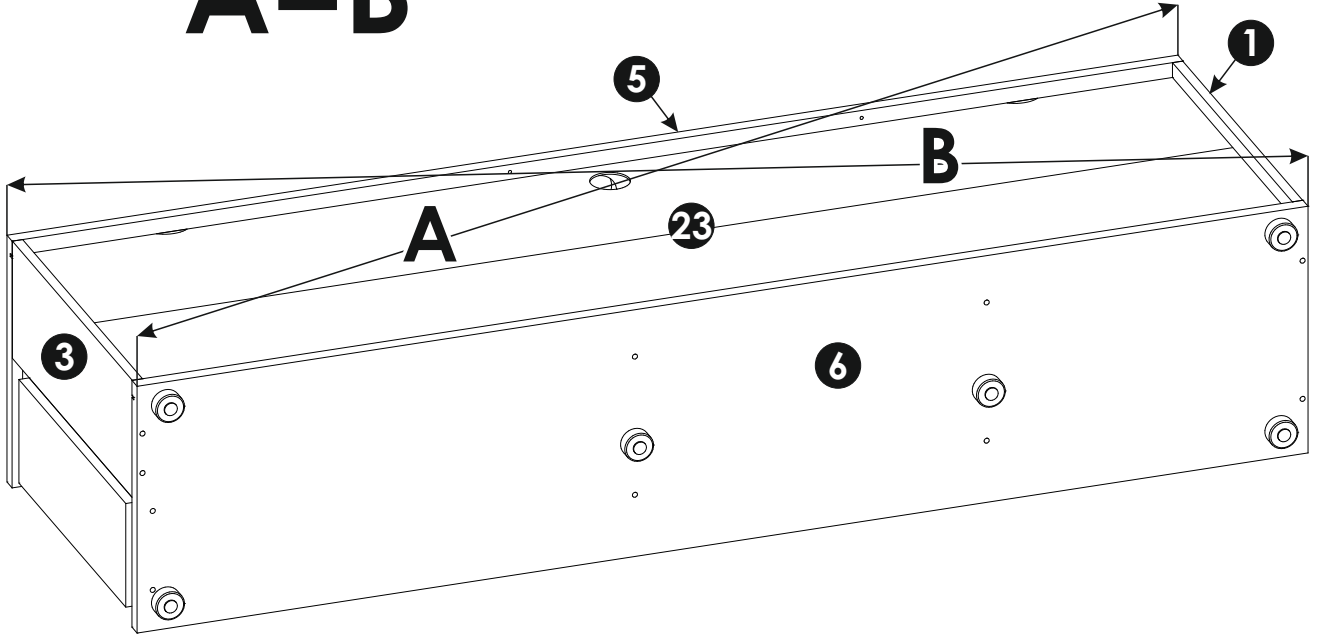

26 ▶

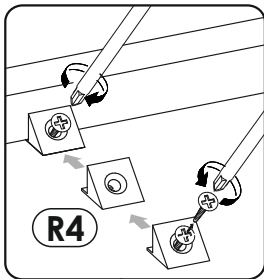
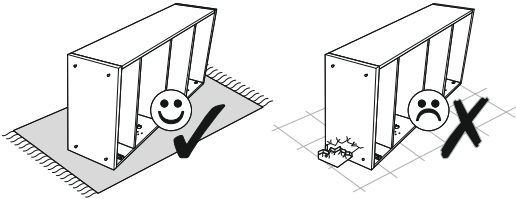

x12

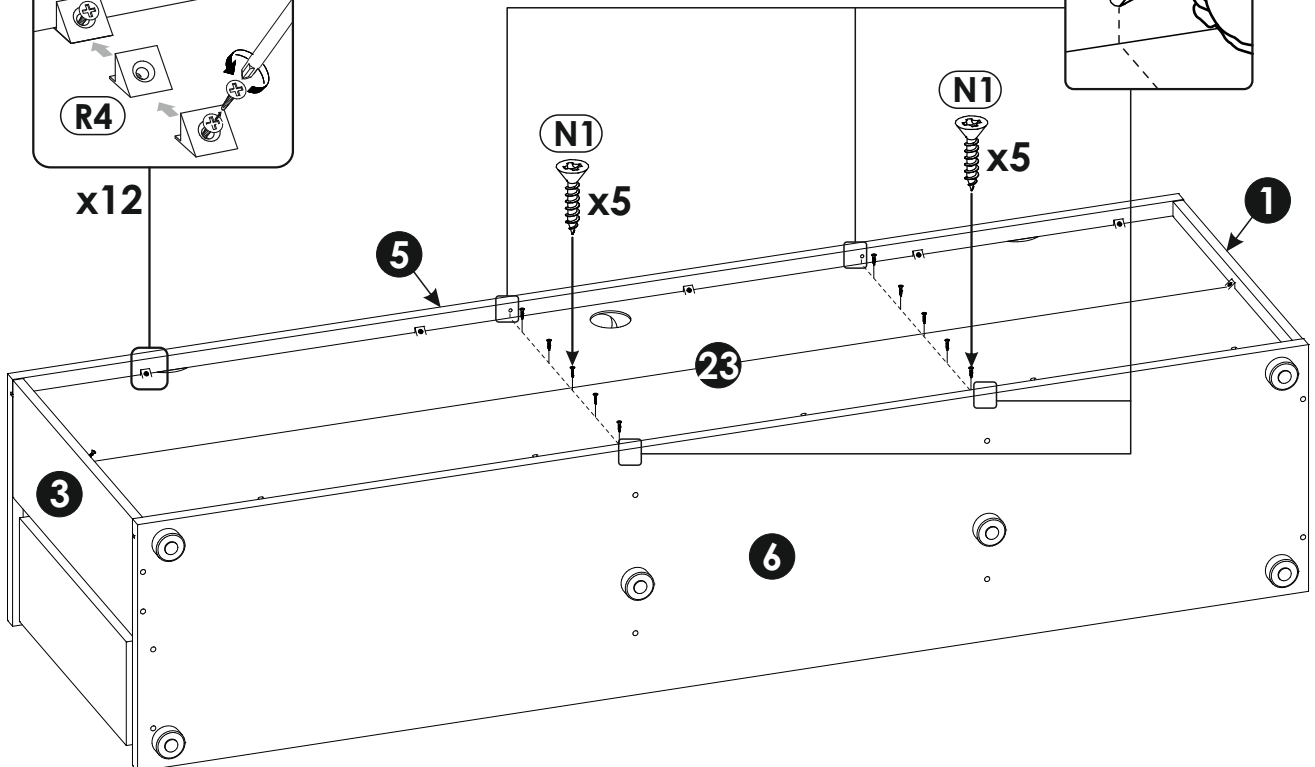
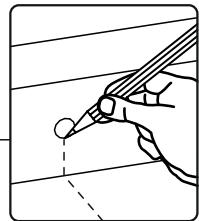

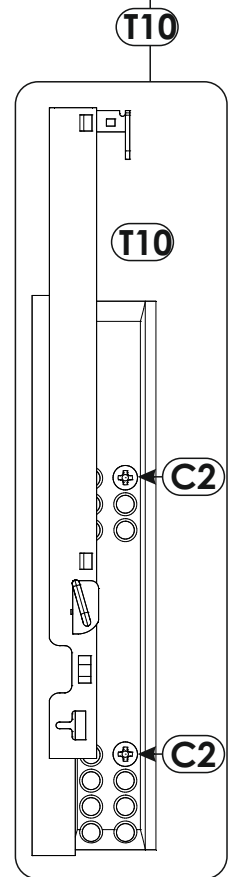
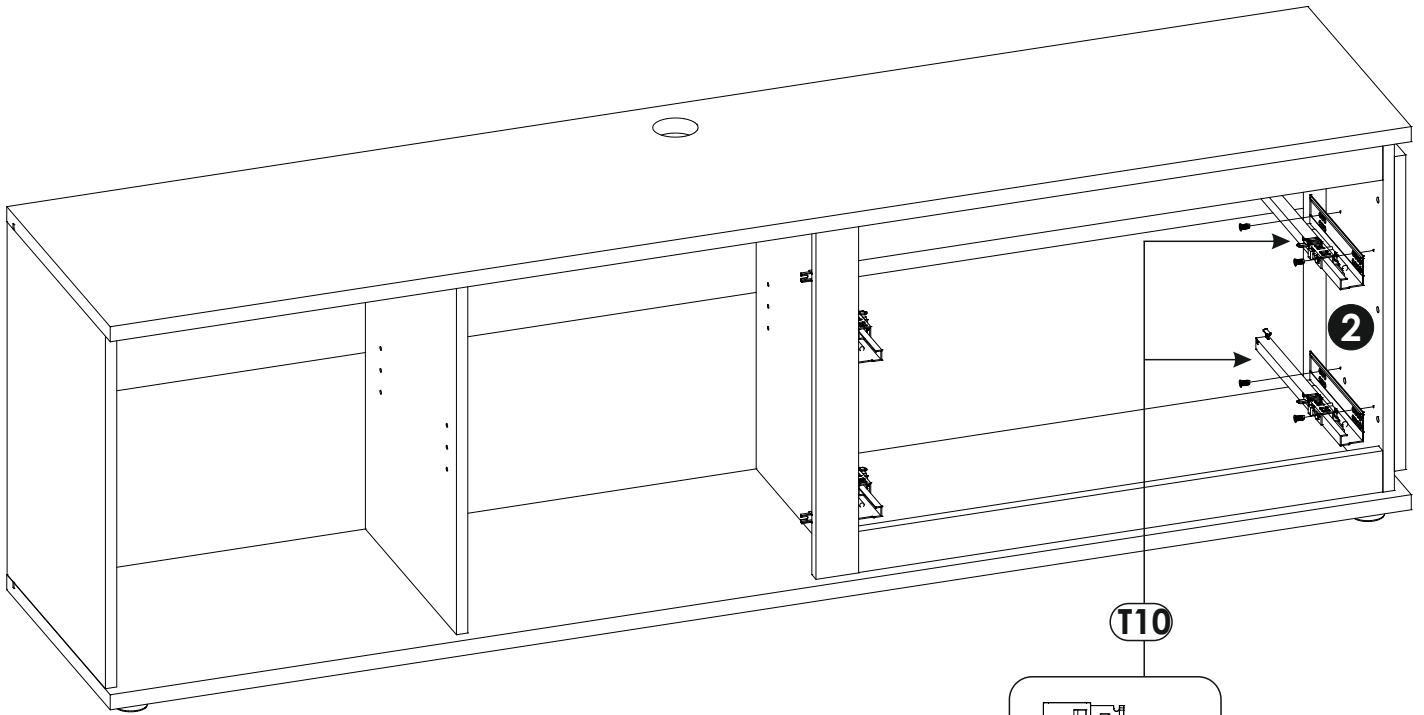

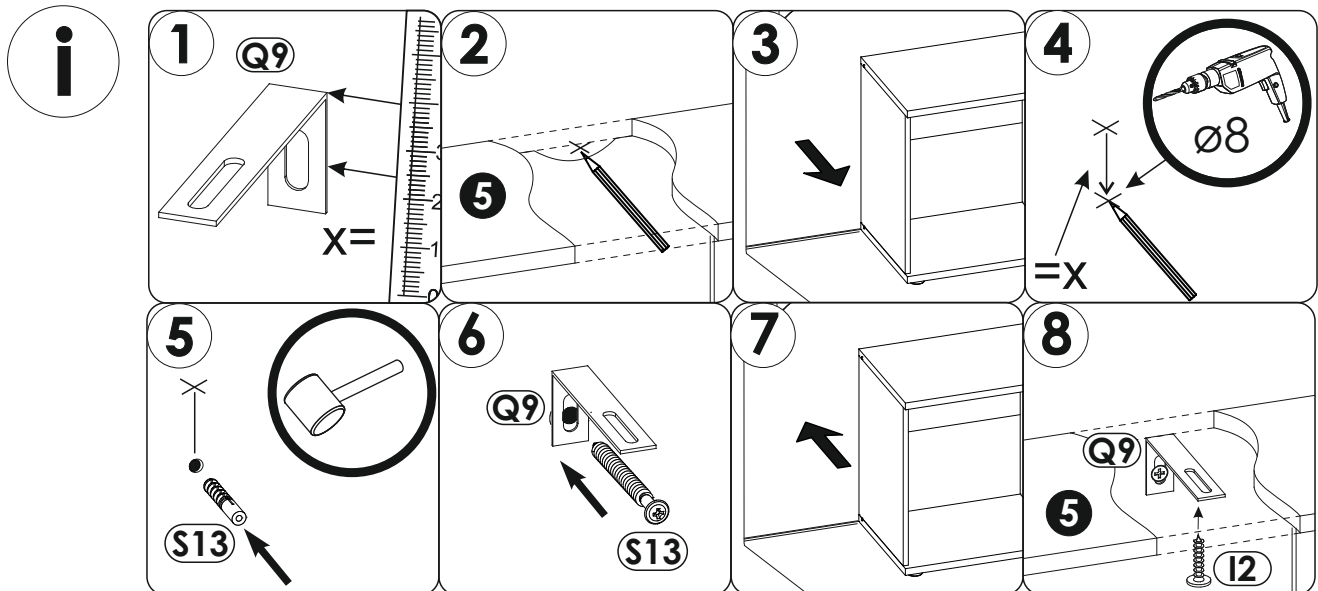
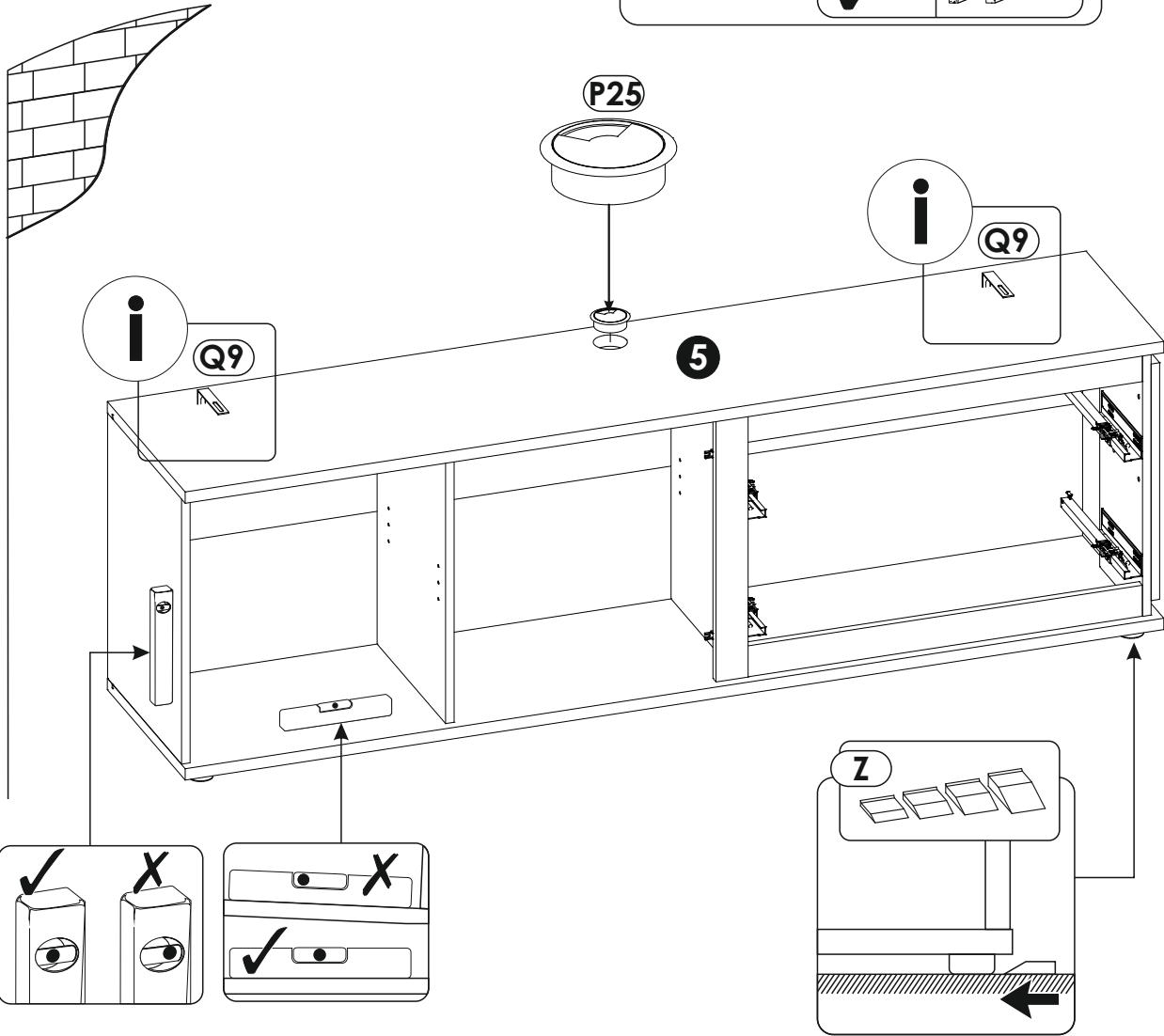
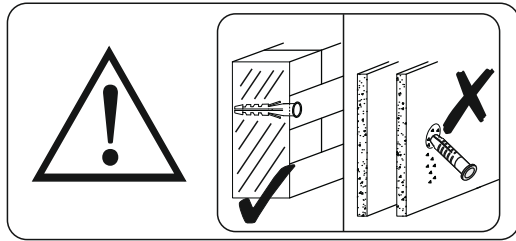

29 ▶

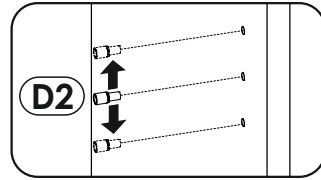
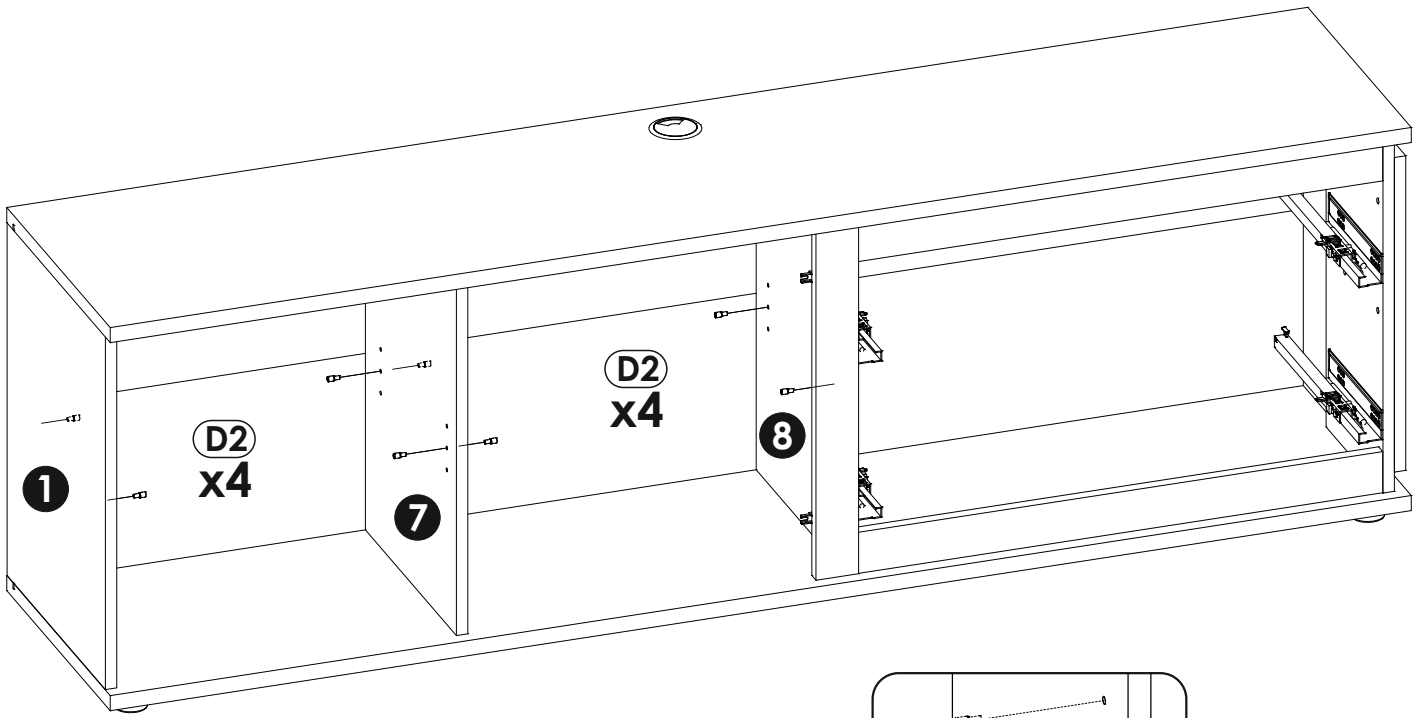

30 ▶

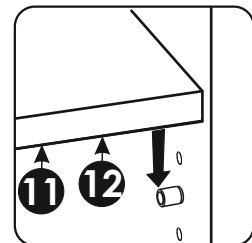
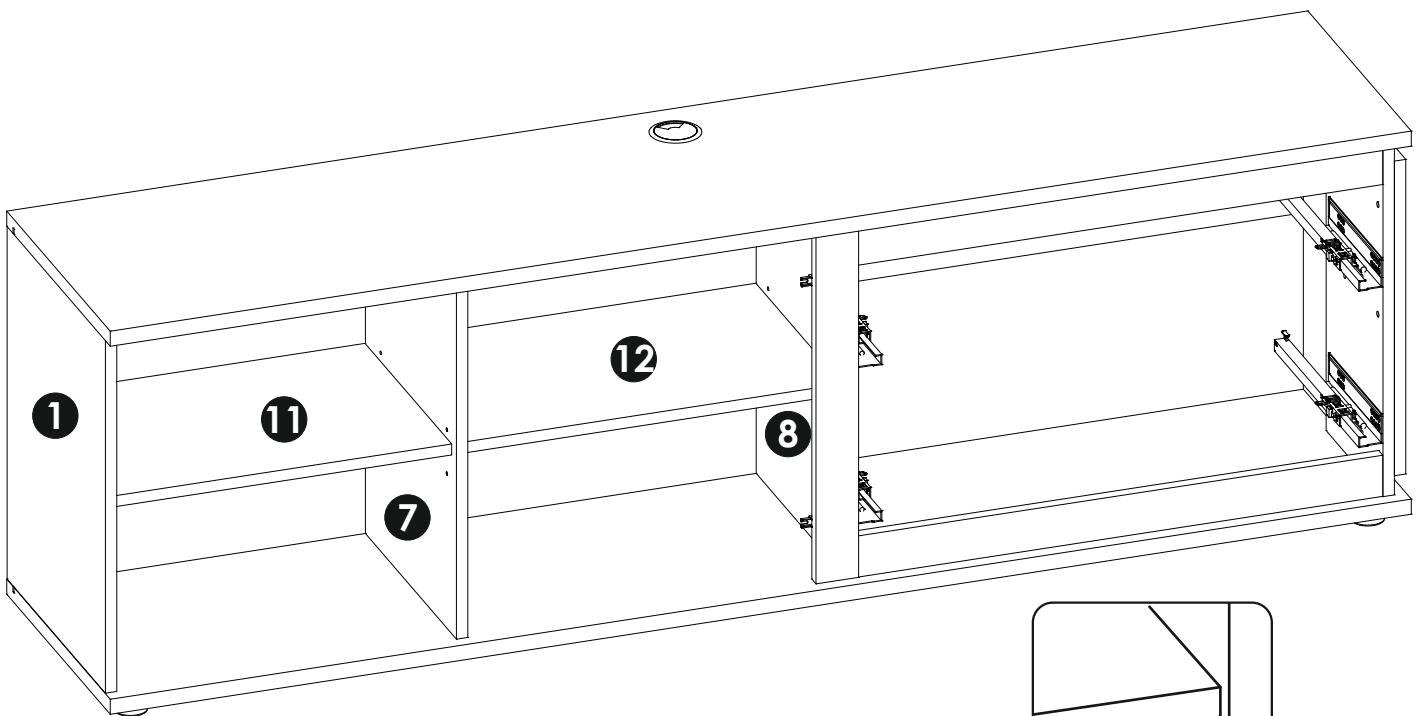

31 ▶

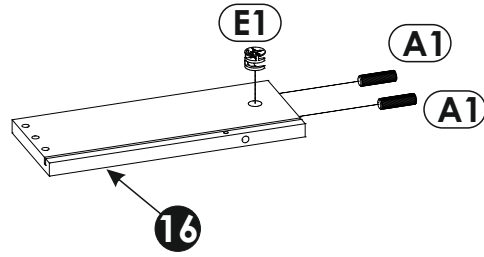
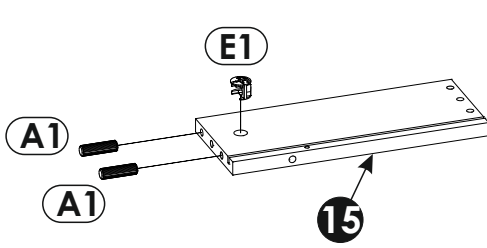
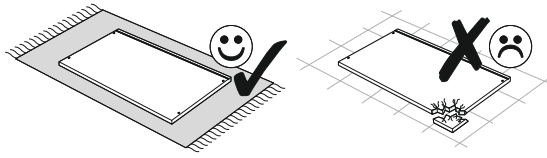

32 ▶

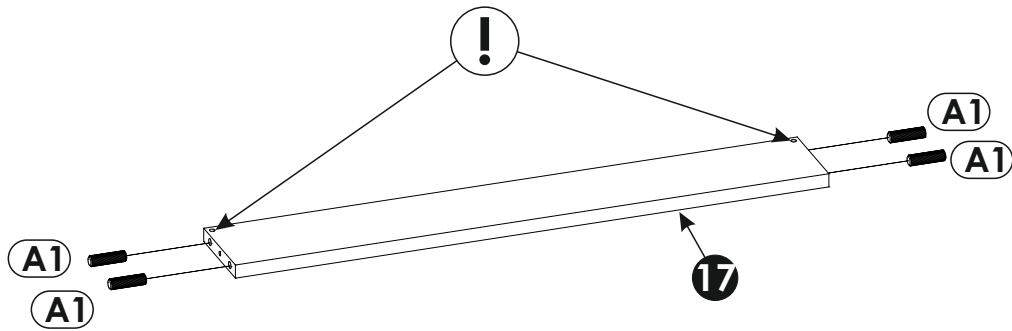
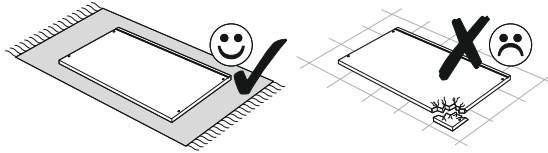

33 ▶

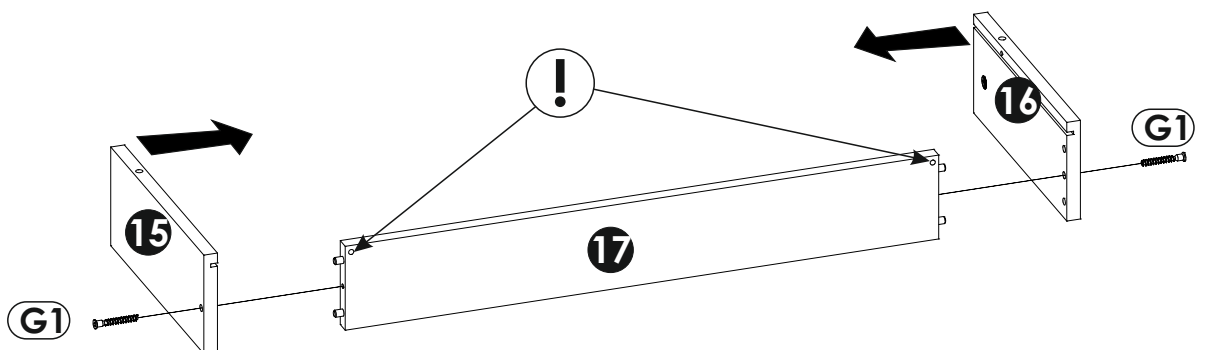
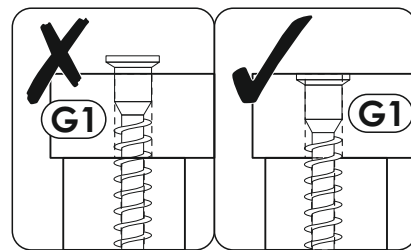
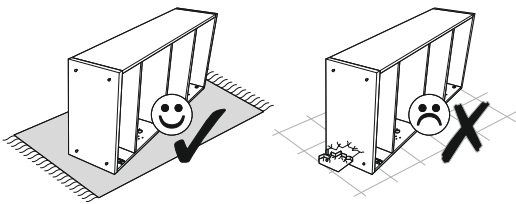

34 ▶

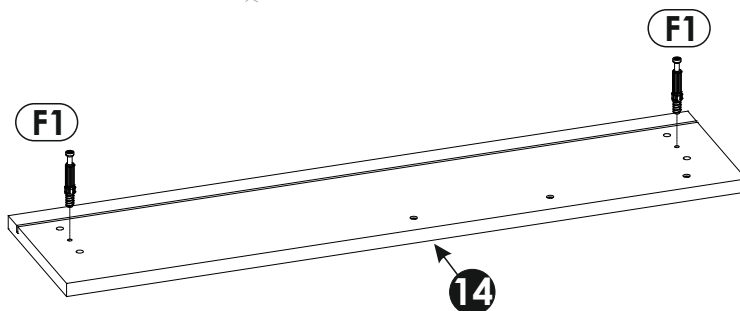
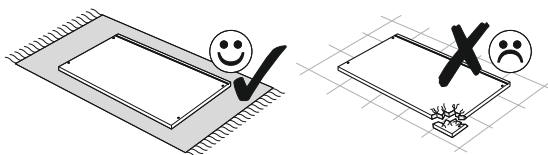

35 ▶

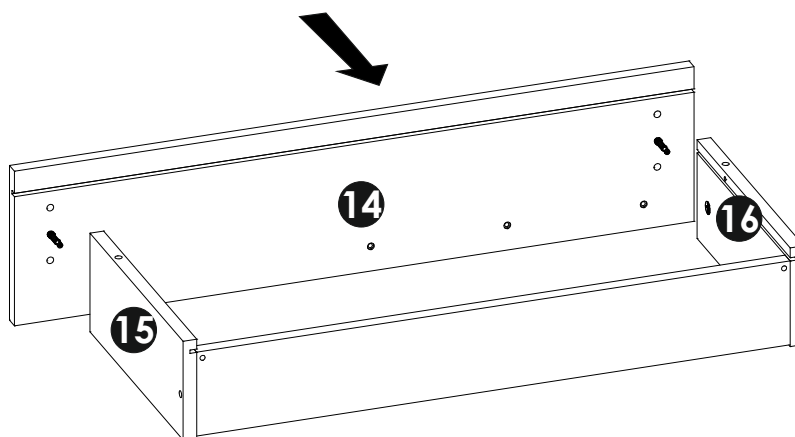
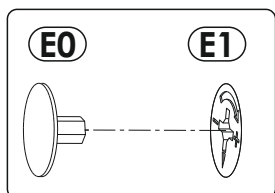
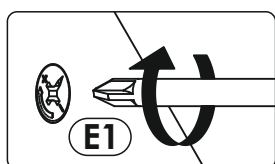
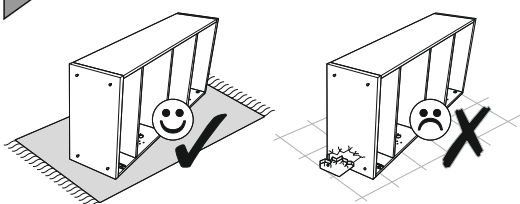

36 ▶

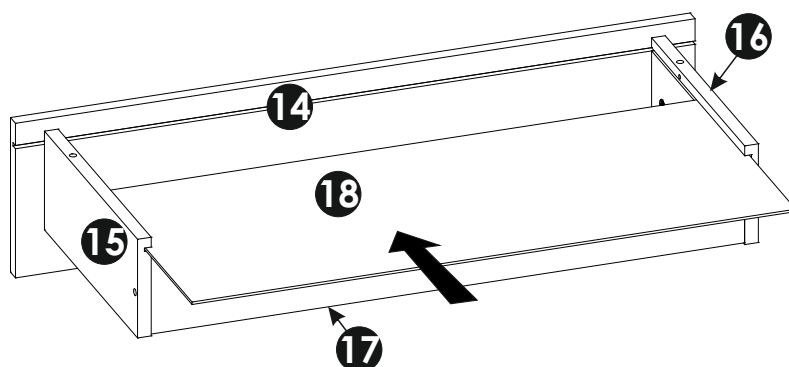
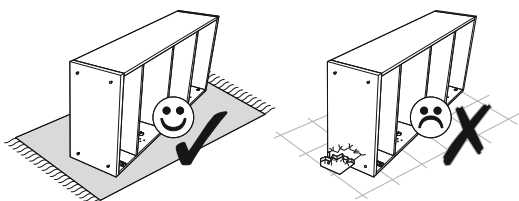

37 ▶

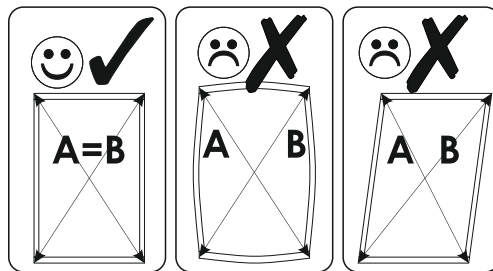
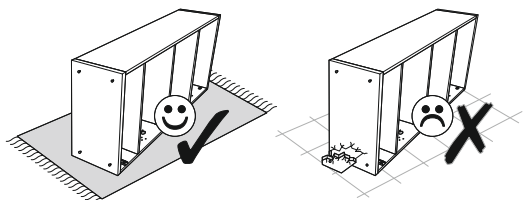

A=B

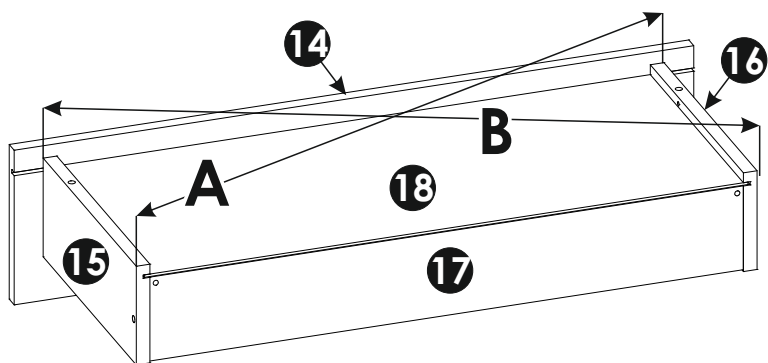

38 ▶

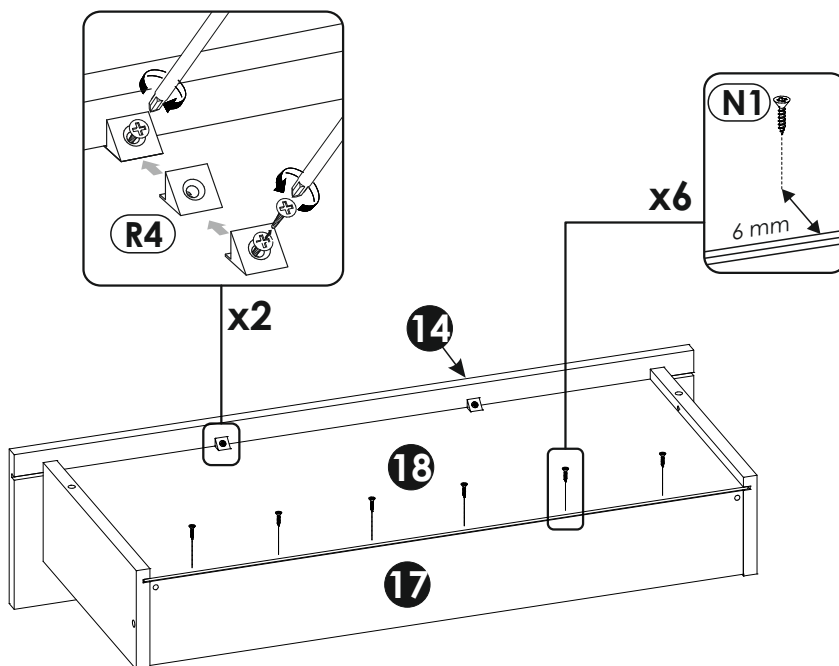
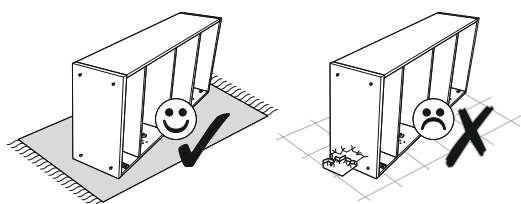

39 ▶

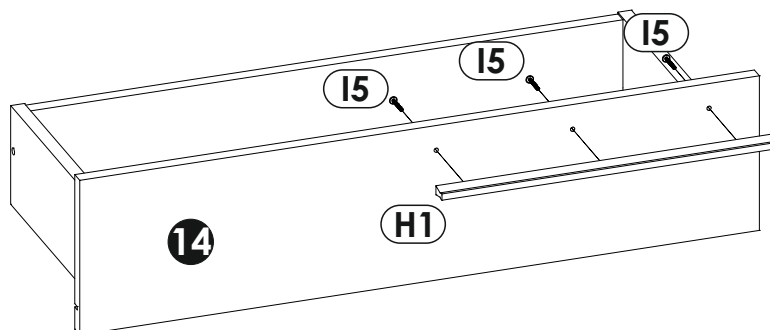
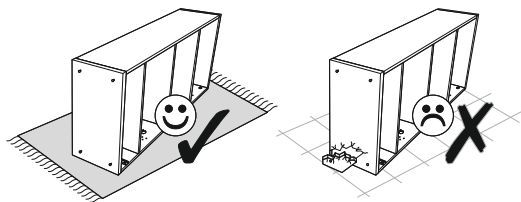

40 ▶

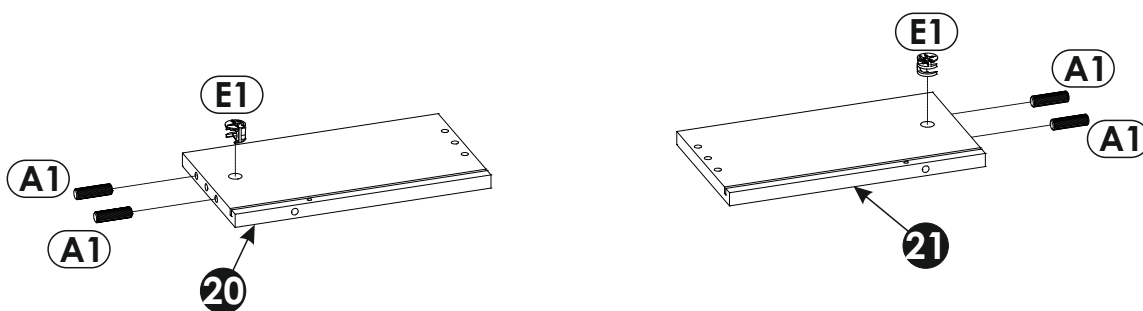
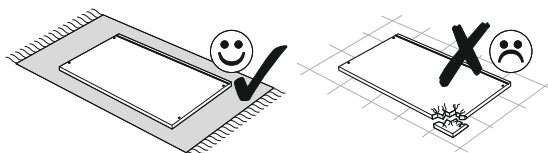

41 ▶

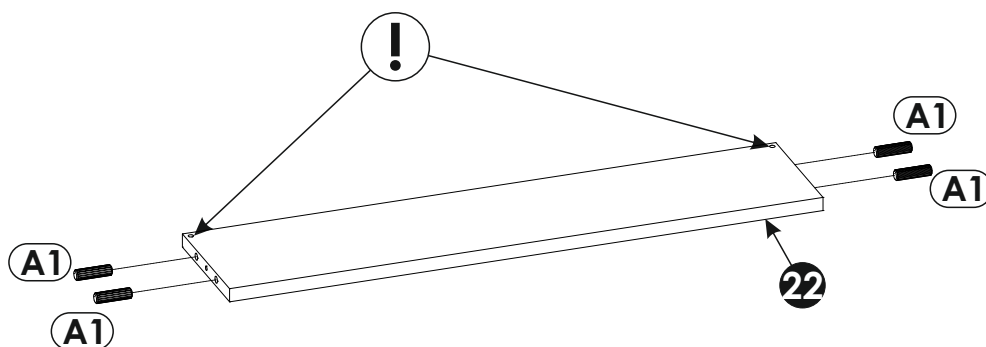
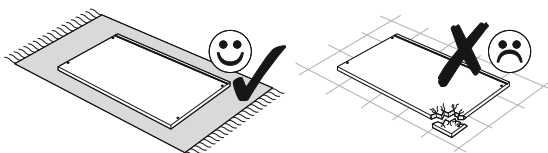

42 ▶

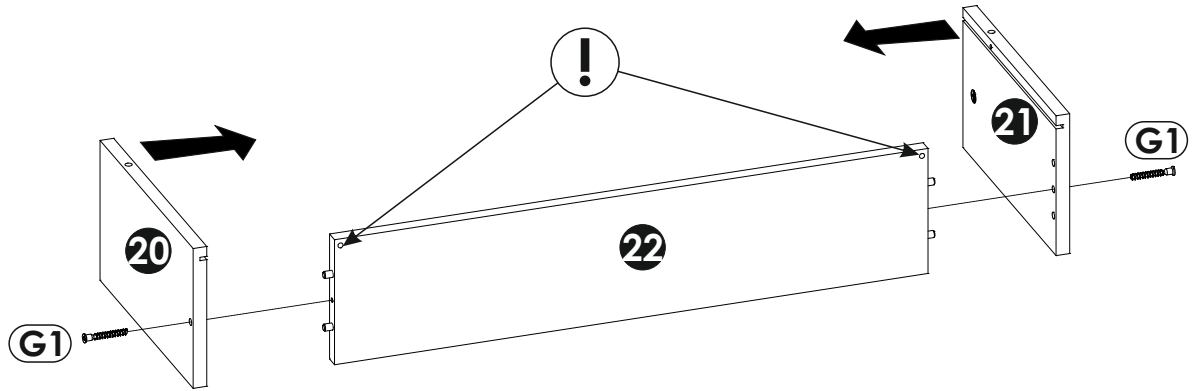
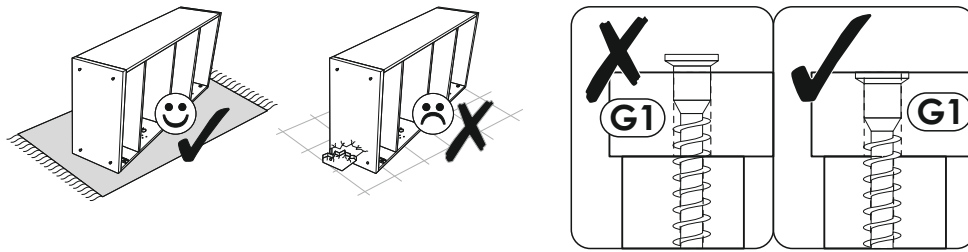

43 ▶

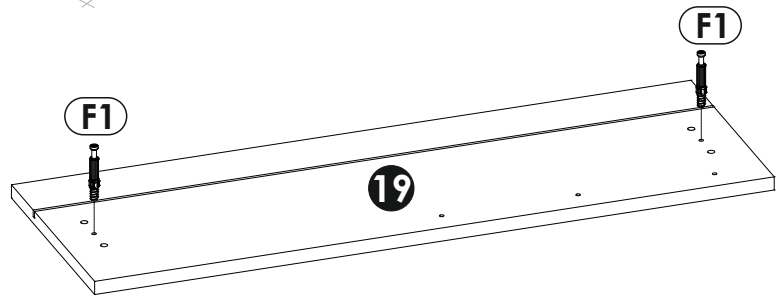
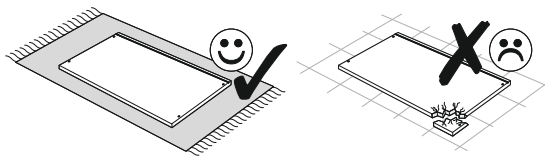

44 ▶

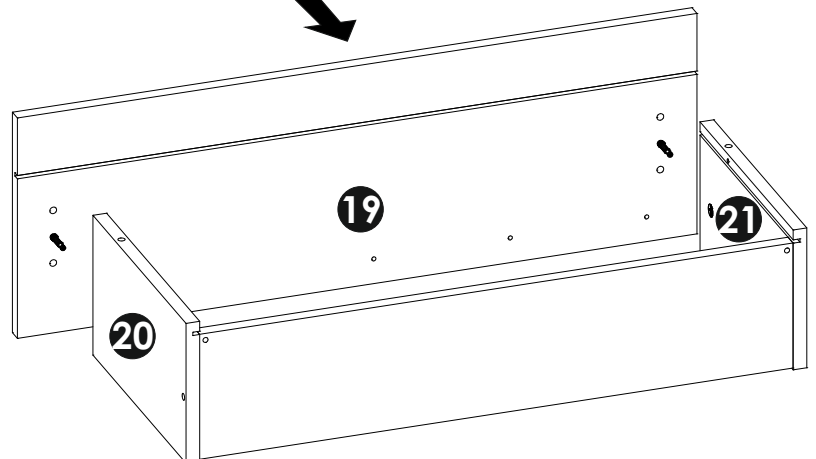
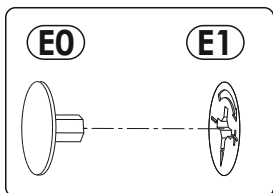
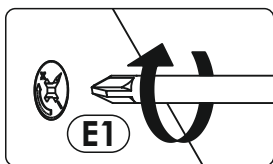
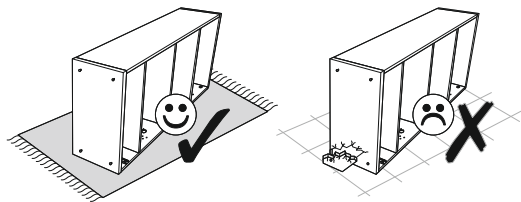

45 ▶

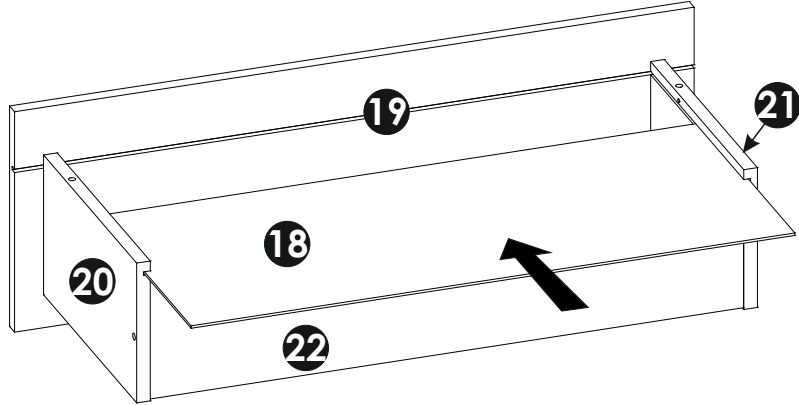
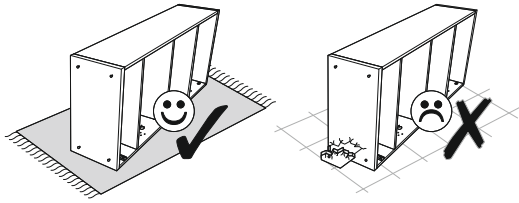

46 ▶

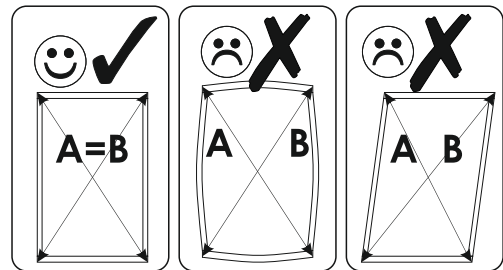
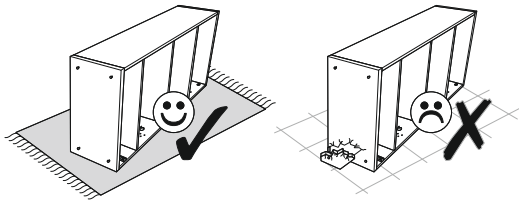

A=B

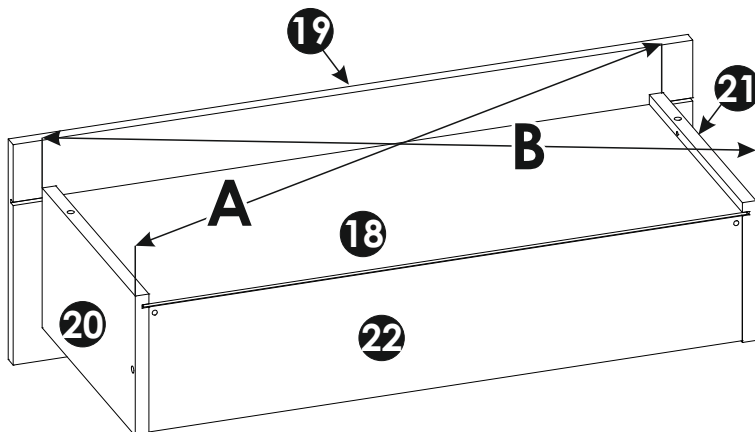

47 ▶

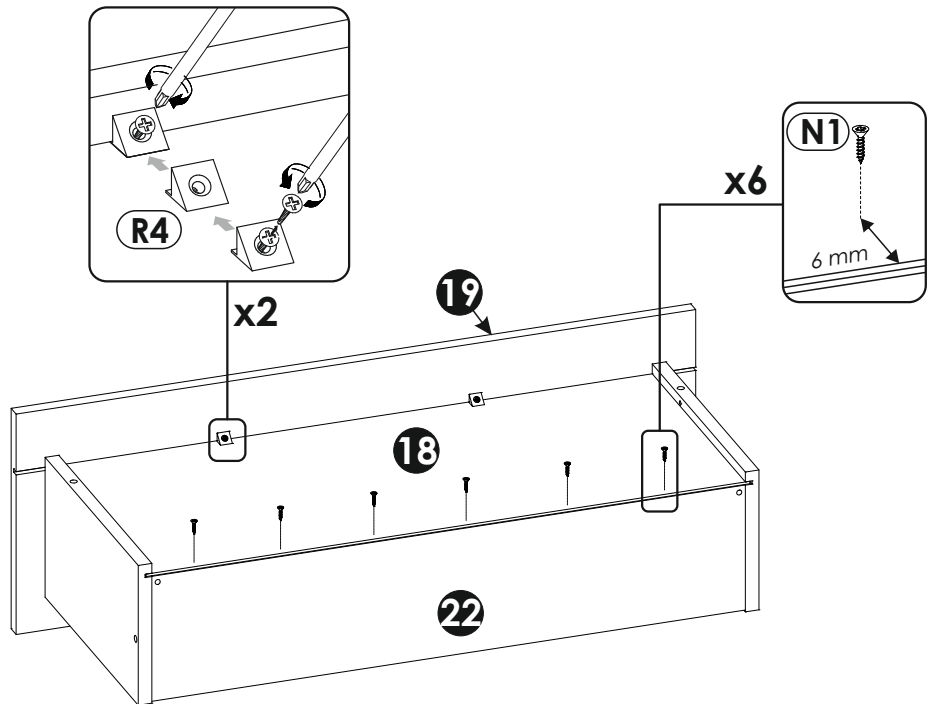
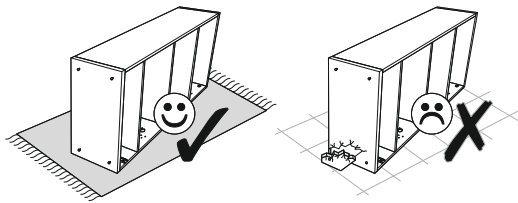

48 ▶

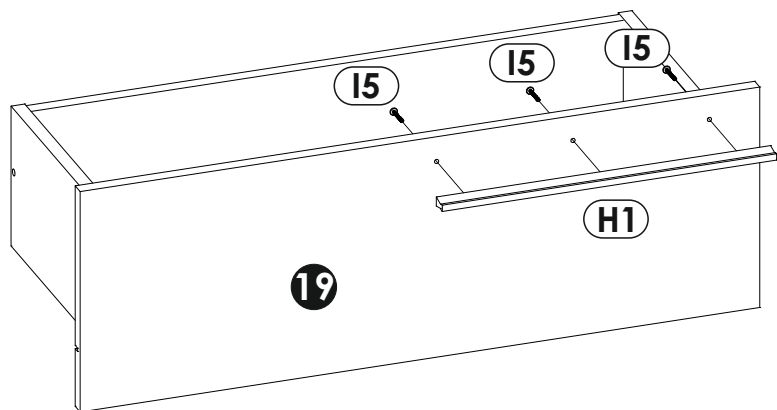
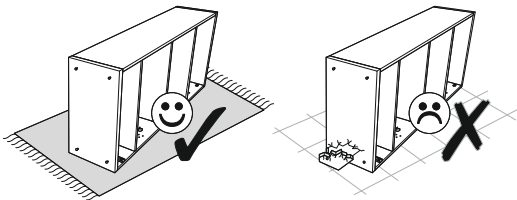

49 ▶

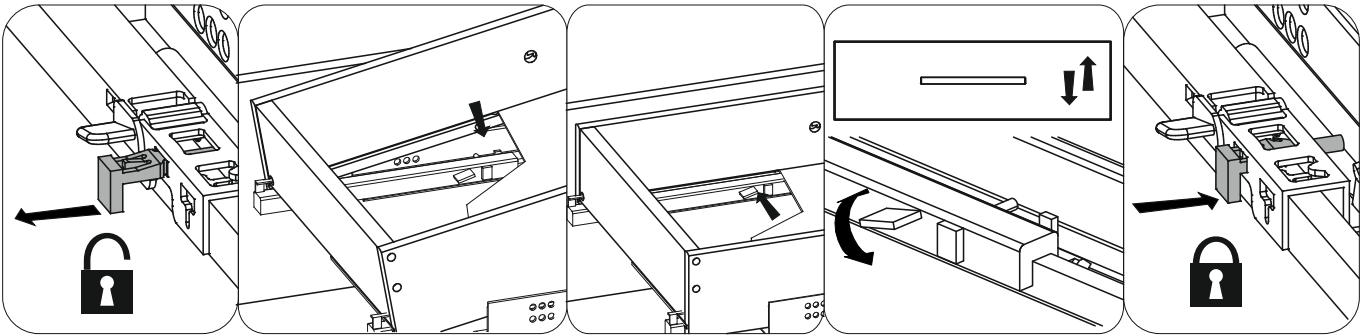
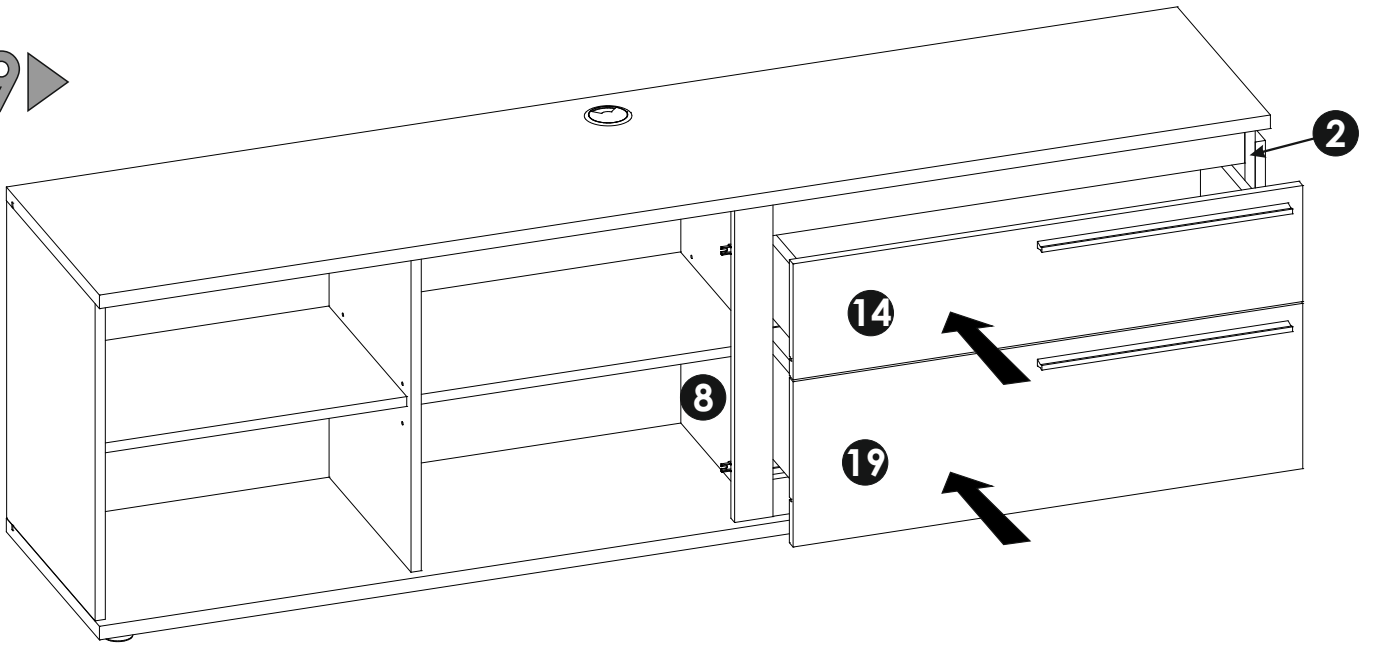

50 ▶

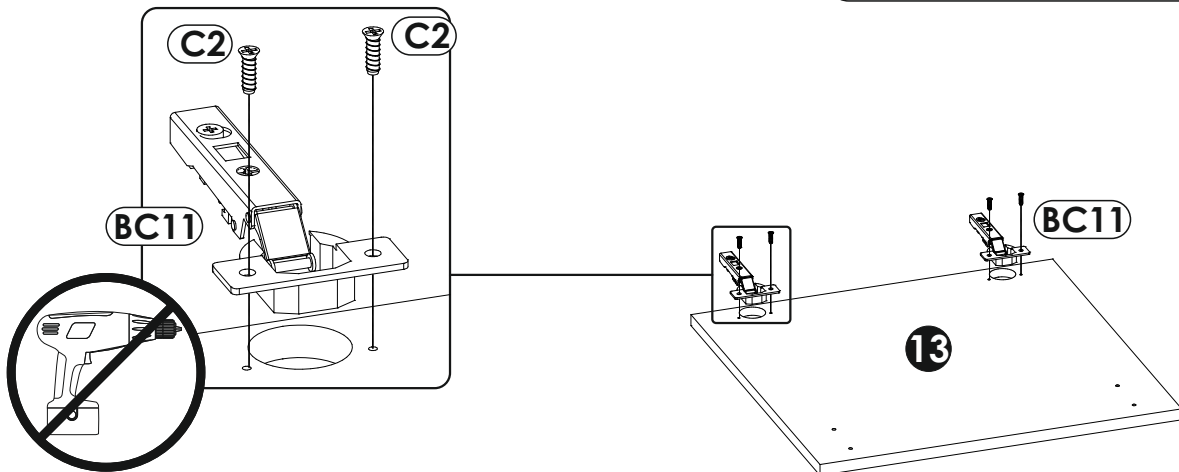
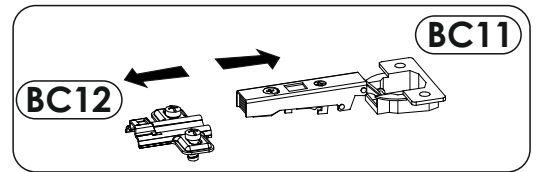
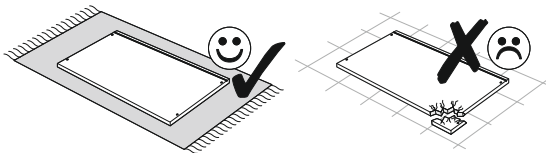

51▶

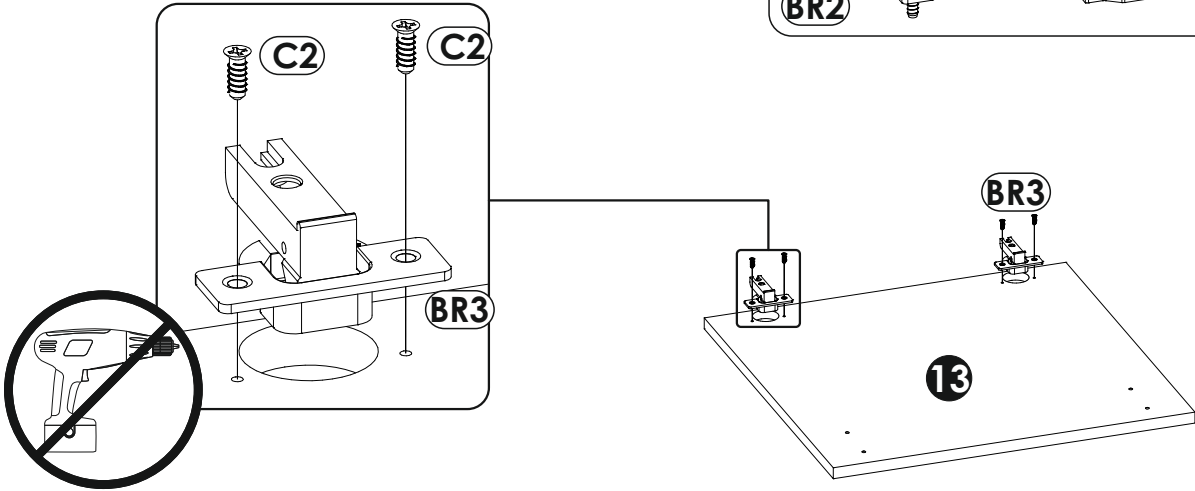
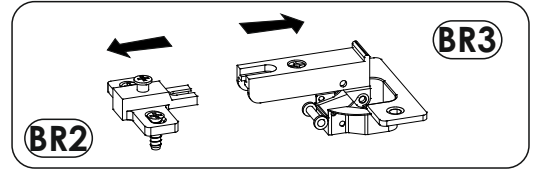
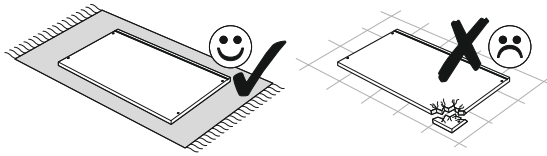

52▶

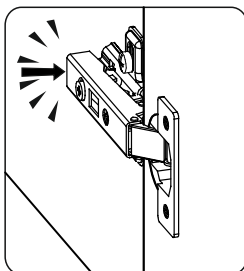
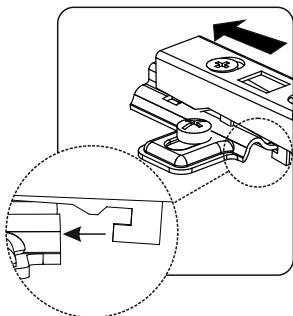
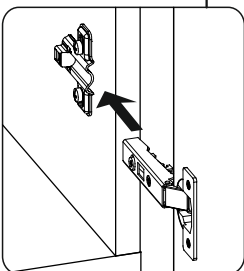
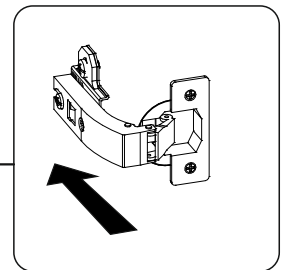
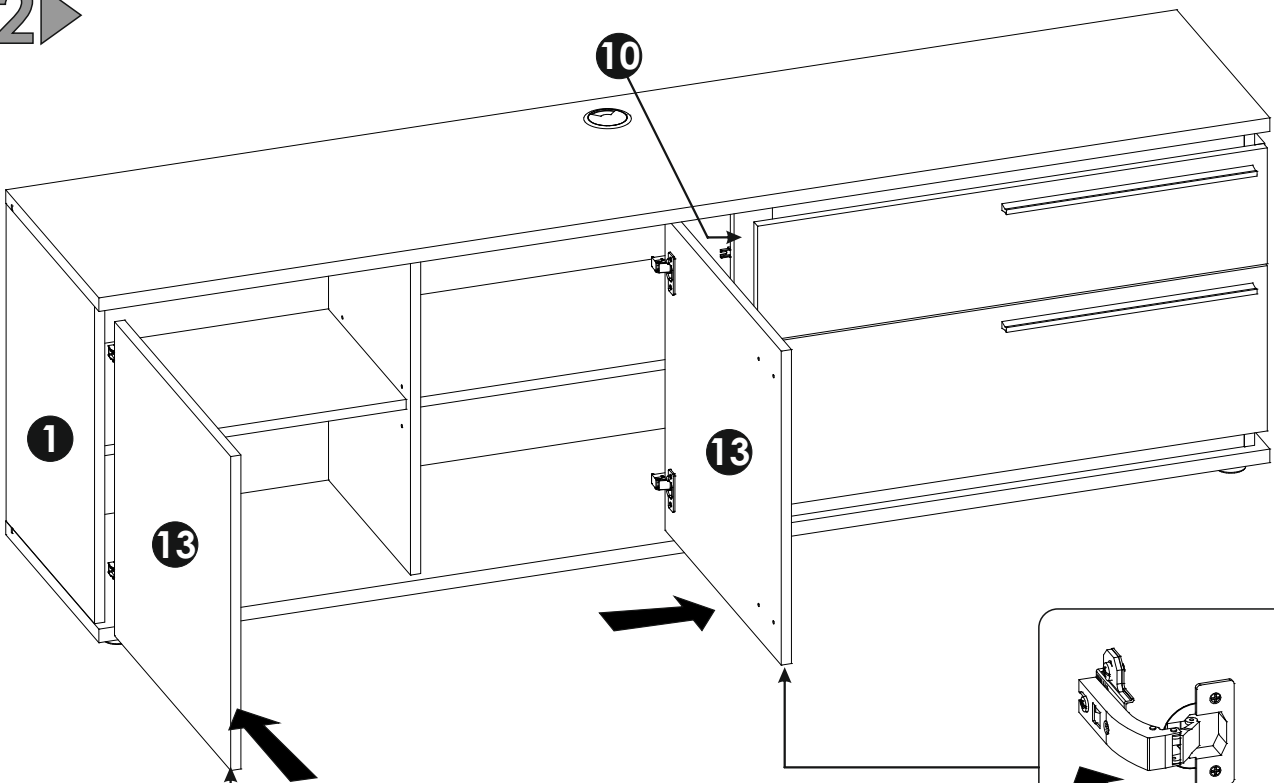

53 ▶

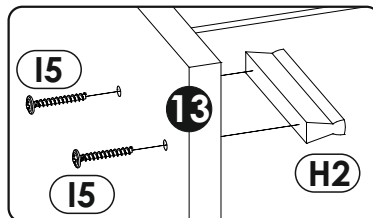
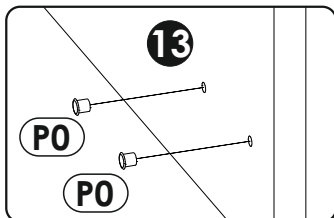
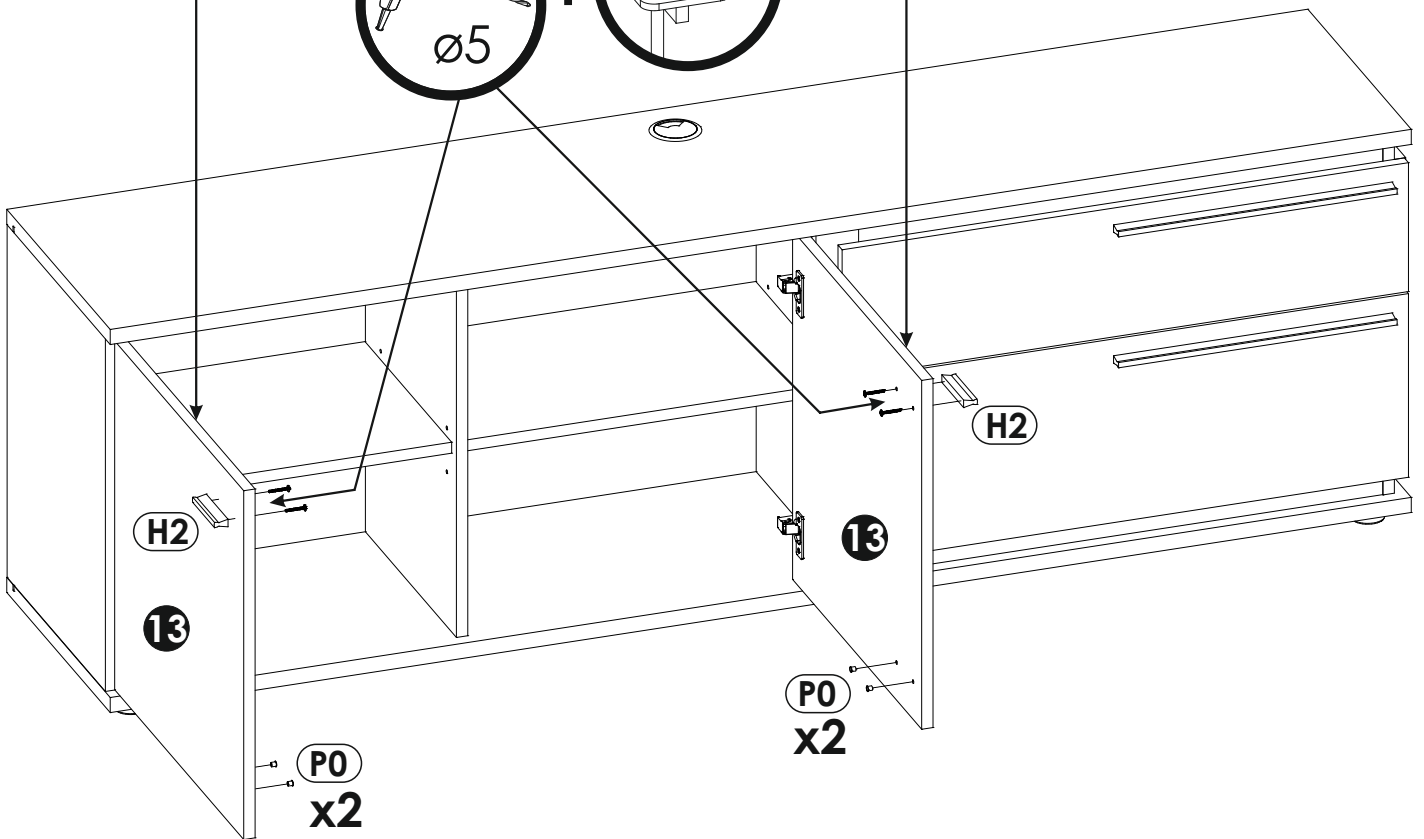
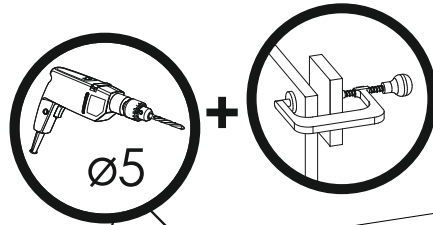
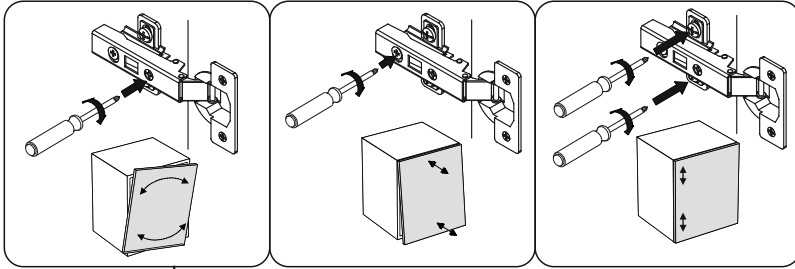
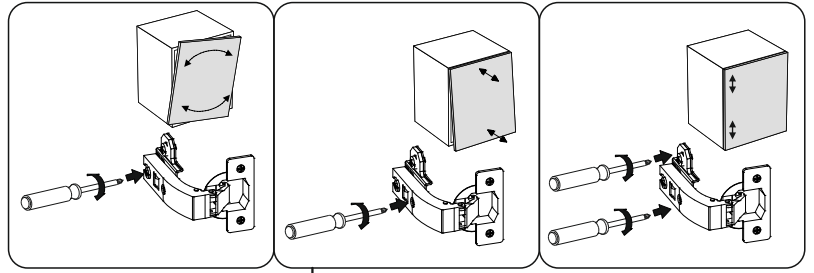

54▶

